

RK05 Subsystem Maintenance SPI Course

Laboratory Projects Workbook

EY-D2067-WB-001

RK05 Subsystem Maintenance SPI Course

Laboratory Projects Workbook

A Portion Of Course
EY-D2079-SP-001

Prepared by Educational Services
Digital Equipment Corporation

Copyright © 1980 by Digital Equipment Corporation

All Rights Reserved

The reproduction of this material, in part or whole, is strictly prohibited. For copy information, contact the Educational Services Department, Digital Equipment Corporation, Bedford, Massachusetts 01730.

The information in this document is subject to change without notice. Digital Equipment Corporation assumes no responsibility for any errors which may appear in this document.

Printed in U.S.A.

The following are trademarks of Digital Equipment Corporation, Maynard, Massachusetts.

DEC	DECUS	DECnet
DECsystem-10	DECSYSTEM-20	DECwriter
DIBOL	Digital Logo	EduSystem
IAS	LSI-11	MASSBUS
OMNIBUS	PDP	PDT
Q-BUS	RSTS	RSX
UNIBUS	VAX	VMX
	VT	

CONTENTS

RK05/RK05J PREVENTIVE MAINTENANCE

APPENDIX A - 8 TO 20 V (+15 V) REGULATOR ADJUSTMENT PROCEDURE

+15 V Regulator Adjustment.....	A-1
-15 V Regulator Adjustment.....	A-3

APPENDIX B - THE RK05-TA OFF-LINE TESTER

Move Functions.....	B-1
Indicators.....	B-1
Write Functions.....	B-1
Connecting The RK05-TA Off-Line Tester To The RK05 Disk Drive..	B-2

APPENDIX C - RK05 MAINTENANCE PROGRAMS

PDP-11 Family.....	C-1
PDP-11 Oscillating Seek Program.....	C-1
General Operating Instructions.....	C-1
PDP-8 Family.....	C-4
Alignment Program Listing.....	C-4
Switch Register Bit Function.....	C-4
Program Operation.....	C-5

APPENDIX D - RK05 SERVO ADJUSTMENTS

Static Adjustments.....	D-1
Dynamic Adjustments.....	D-3

APPENDIX E - RK05 HEAD ALIGNMENT PROCEDURES

Introduction.....	E-1
General Information.....	E-1
Drive Preliminary Set-Up.....	E-2
Positioner Track Scale Alignment.....	E-3
Seek To The Alignment Cylinder (RK05/RK05J).....	E-4
Seek To The Alignment Cylinder (RK05F).....	E-5
Head Waveform Check.....	E-5
Head Alignment Procedure.....	E-9

APPENDIX F - INDEX/SECTOR TIMING ADJUSTMENT

APPENDIX G - READ DATA SEPARATOR ADJUSTMENT

FIGURES

Fig. No.	Title	Page
PM-1	Prefilter.....	3
PM-2	RK05J Disk Drive (Bottom View).....	4
PM-3	Carbon Brush Replacement.....	5
PM-4	Blower Motor Removal.....	6
PM-5	Full Stroke Profile Waveform.....	10
PM-6	Full Stroke Position Waveform.....	11
PM-7	Negligible Runout.....	13
PM-8	Considerable Runout.....	14
PM-9	RK05K-AC Head Alignment Waveform.....	15
PM-10	Index/Sector Waveform.....	18
A-1	8-20 Volt Regulator.....	A-1
A-2	C4 Waveform.....	A-2
A-3	Gain Waveform.....	A-3
D-1	Sine Amplitude/Offset and Velocity Offset Waveform....	D-4
D-2	Cosine Amplitude/Offset Waveform.....	D-5
D-3	Velocity Amplitude Waveform.....	D-6
D-4	Acceleration Waveform.....	D-7
D-5	Full Stroke Waveform.....	D-8
D-6	Full Stroke Position Waveform.....	D-8
D-7	Outer Limit Waveform.....	D-9
E-1	Location of Scale Retaining Screws.....	E-3
E-2	How to Read a Vernier.....	E-4
E-3	RK05K-AC Head Alignment Waveform.....	E-6
E-4	Read/Write Head Adjustments.....	E-9
F-1	How to Read A Vernier.....	F-2
F-2	Index/Sector Waveform.....	F-4

TABLES

Table No.	Title	Page
D-1	Location of Servo System Adjustment Potentiometers...	D-1

RK05/RK05J
Preventive Maintenance

NOTE

Quarterly PM (750 hours) consists of Steps 1 through 6, and Steps 13 and 20.

Annual PM (3000 hours) consists of Steps 1 through 8, and Steps 11 through 20.

Five year PM (15000 hours) consists of all the steps.

1. PREPARE DRIVE FOR INSPECTION.
 - Remove cartridge.
 - Remove power from drive.
 - Extend drive on its chassis tracks.
 - Remove top cover.

2. INSPECT EACH HEAD USING AN INSPECTION MIRROR. CHECK FOR DAMAGE OR THE FOLLOWING TYPES OF CONTAMINATION.
 - Hydrocarbon (tar-like substance) deposits on leading edge of head. These deposits may be removable by cleaning.
 - Light brown streaks (oxide deposits) on the surface of the head. This indicates that the user's disk cartridge should be cleaned and the air filters checked. The heads should be cleaned as well.
 - Stains, film, residue or cracks. Replace the head if cracked; stains, film or other residue may be removable by cleaning.
 - Scratches, burns and nicks on the face of the head. A succession of tiny grooves indicate an imbedded particle on a disk surface which could still be present on the disk. A head with these characteristics should be replaced.
 - Damaged or missing foam seals from the head wires.

3. CLEAN THE READ/WRITE HEADS.
 - Use an alcohol wipe and wand (cleaning kit - DEC 22-0007).
 - Apply only light pressure to the head surface when cleaning. The heads are fragile and the gimbal mounts can be damaged.
 - Wipe off all alcohol residue.

- Use a clean, dry, lint-free cloth wrapped around the wand.
 - If stains or deposits cannot be removed, replace head(s).
4. INSPECT AND CLEAN THE SPINDLE AND SURROUNDING AREA.
- Check for dirt and other types of foreign matter.
 - If found, isolate the source of the particles (cartridge plastic, etc.).
 - Correct the cause to prevent further deposits.
 - Clean the spindle using an alcohol wipe.
 - Wipe off all alcohol residue with a clean, dry wipe.
 - The spindle and spindle cone (as well as the disk cartridge cone) must be clean to prevent cartridge wobble (runout).
5. INSPECT DISK CARTRIDGE(S) USED ON SYSTEM
- Ensure all customer's cartridges are DIGITAL packs as others may not meet specifications.
 - Check for a warped cartridge door on all cartridges used. The door should close upon removal from the drive. Warped doors will cause the center bearing to wear.
 - Check the cartridge for plastic particles.
 - Examine the center bearing button on the cartridge case.
 - The bearing may be seen by viewing the cartridge hub cone. Inside the cone is a round plastic centering device.
 - Excessive wear or misuse may cause this plastic bearing to grind down, leaving particles on the disk surface or spindle area, or both.
 - Examine the disk surface.
 - Open the cartridge "door" and view the surface using a good light.
 - Rotate the cartridge and check for contamination (lumps, scratches, plastic particles, burn marks, etc.).

- Ensure that the customer is aware that the cartridges being used on the system should be professionally cleaned at least every six months. Field Service should not attempt to hand-clean a cartridge by disassembling the cartridge case.

NOTE

Shiny spots on outside edge of disk, or dull rub marks on top surface (from edge to approximately 3/4 inch in), are caused by the cartridge hitting the duckbill when cartridge is inserted into drive. These normally do not affect the operation of the cartridge.

Check for divots (holes, dings, etc.) in the disk surface approximately 3/4 inch in from edge of disk. This is caused by a tilted head or a bent gimbal during a head load operation. If divots are found, change the head.

6. CLEAN THE PREFILTER (ON A 750 HOUR PM) OR REPLACE IT (3000 HOUR PM). REFER TO FIGURE PM-1.
 - Vacuum clean or wash with soap and water.
 - Dry thoroughly before reinstallation.

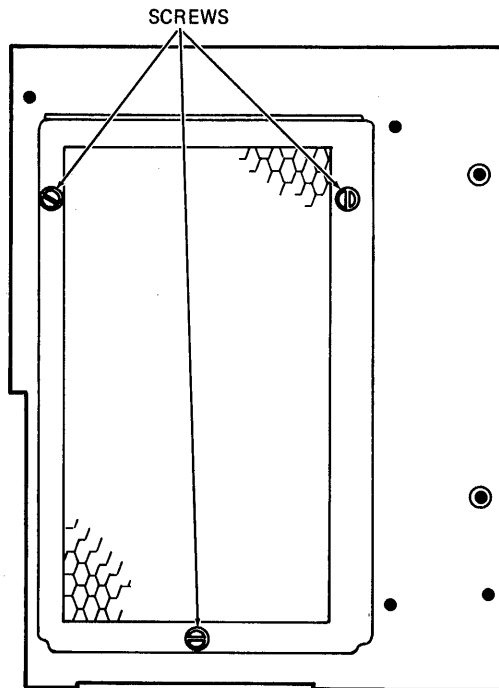

Figure PM-1 Prefilter

CAUTION

Interface cable (not shown) will be installed around the outside of the filter. Do not block air flow through the filter with the cable. Do not make loops in the cable so large that it is pinched when sliding the chassis in or out of the cabinet.

7. REPLACE THE ABSOLUTE FILTER (DEC P/N 12-12175-01 IF ECO #64 HAS BEEN INSTALLED).
 - Extend the drive on its chassis tracks.
 - Remove the bottom cover.
 - Loosen the hose clamp and remove the filter (Figure PM-2).

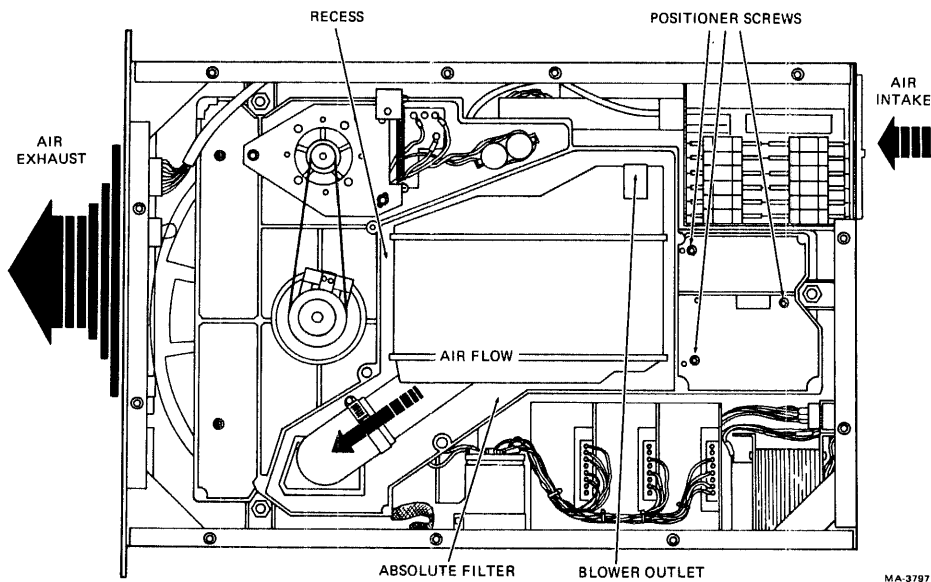

Figure PM-2 RK05J Disk Drive (Bottom View)

- Clean any dusty areas of the filter housing.
- Ensure that new filter is snapped into the port under the blower.
- Ensure that the air flow direction arrow is exposed and pointing in the proper direction.
- Tighten the hose clamp.

8. CHECK THE INSIDE OF THE BOTTOM COVER OF THE DRIVE FOR EVIDENCE OF RUBBING OR SCRAPING.

- Can be caused by distorted or weak shock mounts.
 - Replace shock mounts as needed.
- Can also be caused by a slipped drive pulley.
 - Adjust if necessary.

9. REPLACE THE SPINDLE BRUSH ASSEMBLY.

- Remove the two screws holding the brush assembly (Figure PM-3).

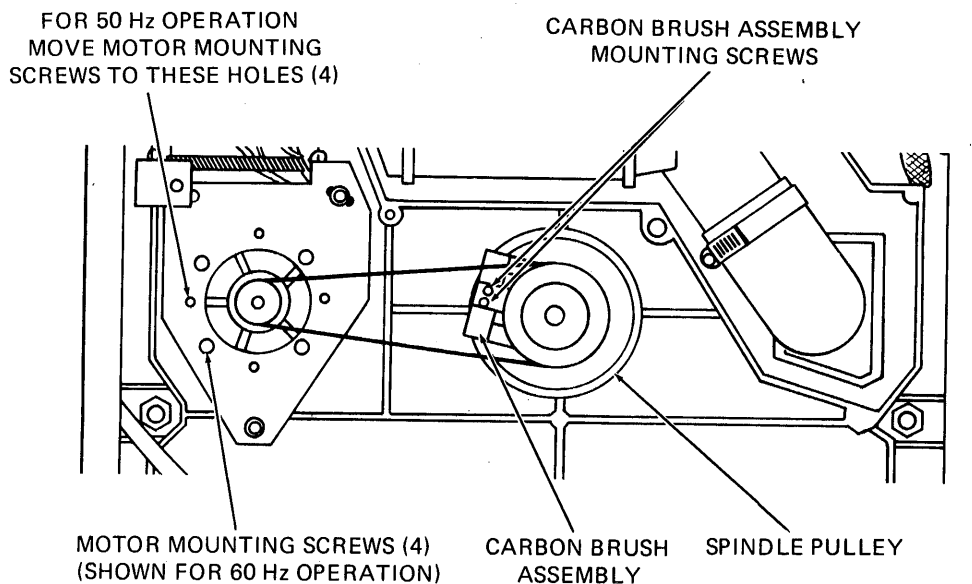

MA-3788

Figure PM-3 Carbon Brush Replacement

- Install the new brush assembly ensuring full contact of the brushes to the shaft.
 - Ensure that the curved area of the brushes are centered on the spindle hub.
 - Ensure that the brush assembly is not cocked or twisted.

10. REMOVE AND CLEAN THE BLOWER ASSEMBLY.

- Remove the mounting screws from the blower shroud, being careful not to damage the foam seal (Figure PM-4).

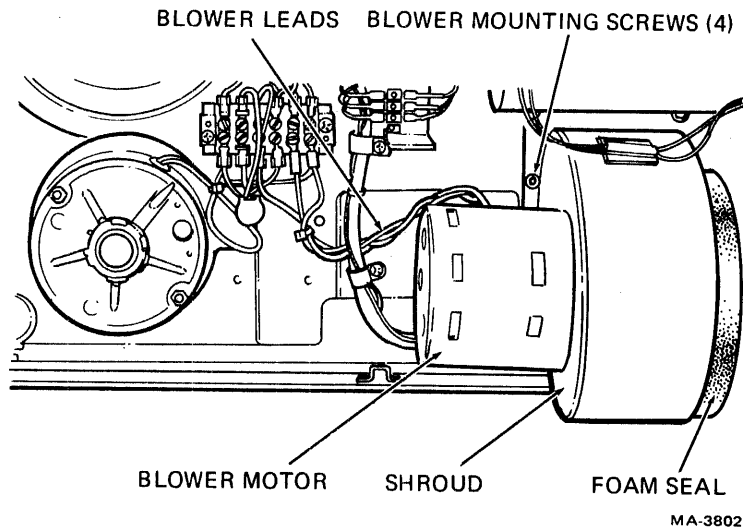

Figure PM-4 Blower Motor Removal

- Remove the blower motor wires from TB4.
- Lift the blower assembly out of the drive.
- Loosen the locking screws holding the impeller to the motor shaft.
- Clean the impeller in warm soapy water and dry it completely.
- Wipe the inside of the blower housing clean.
- Reinstall the impeller end plate.
 - Ensure that the screws are tight and that the impeller is located on the shaft so that it will not make contact with the motor or the inlet ring
 - Reinstall the assembly on the baseplate and reconnect the wires on TB4

11. CLEAN THE LOWER SPINDLE AREA AND DRIVE PULLEYS.

- Remove spindle drive belt.
- Use an alcohol wipe.
- Wipe off any alcohol residue with a clean, dry cloth.

12. INSPECT THE SPINDLE DRIVE BELT.

- If frayed or cracked, install a new belt.
- Push spindle motor mounting plate toward the spindle.
- Slip belt around pulleys.

NOTE

Never pull the belt into position. This could stretch the belt.

13. CHECK THE LINEAR POSITIONER BEARINGS FOR WEAR.

- Using a fresh alcohol wipe, clean the linear positioner bearing guides.
- Disable drive to the linear positioner by pushing S1 (on the H604 module) to the OFF position.
- Wring out an alcohol wipe so that it is almost dry.
- Place wrung-out alcohol wipe between read/write heads.
- Manually load heads, overcoming the initial force of the batteries holding the heads at the home position.
- Clean as much of the linear positioner bearing guides as you can reach.
- Move carriage back and forth observing the four carriage bearings. Each should turn smoothly.
 - If carriage does not roll smoothly in the bearing guides, one or more bearings may be worn or have a piece missing.
 - If one or more carriage bearings stop while moving the carriage, the carriage is not properly aligned within the housing.
- If either problem listed above exists, then positioner replacement is recommended.
- Re-enable positioner drive by pushing S1 to the ON position.

NOTE

The heads may have to be unloaded by using hand pressure.

14. CHECK POWER SUPPLY VOLTAGES.

- +5Vdc
 - Reference point is A01A1 (red wire on backplane).
 - Nominal value is $+5V \pm .15Vdc$.
 - Use a good meter to check amplitude.
 - If out of tolerance, adjust R13 on the +5V regulator (visible from bottom of drive).
 - Maximum allowed peak-to-peak ripple is .25V.
 - Use oscilloscope to check ripple.
 - If out of tolerance, replace the regulator.
- +15 Vdc
 - Reference point is A01D2 (orange wire on the backplane).
 - Nominal value is $+15V \pm .75Vdc$.
 - Use a good meter to check amplitude.
 - If out of tolerance, adjust according to the procedures found in Appendix A.
 - Maximum allowed peak-to-peak ripple is .25V.
 - Use oscilloscope to check ripple.
 - If out of tolerance, replace the regulator.
- -15Vdc
 - Reference point is A01B2 (blue wire on backplane).
 - Nominal value is $-15V \pm .75Vdc$.
 - Use a good meter to check amplitude.
 - If out of tolerance, adjust according to the procedures found in Appendix A.
 - Maximum allowed peak-to-peak ripple is .25V.
 - Use oscilloscope to check ripple.
 - If out of tolerance, replace the regulator.

15. RETURN DRIVE TO OPERATIONAL STATUS.

16. SERVO ADJUSTMENTS CHECK.

- Full stroke profile
 - Connect oscilloscope as shown below.
 - Channel 1 probe to A05H1
 - Sweep time = 10 msec/cm
 - Vertical sensitivity = 50 mV/cm (using x10 probe)
dc
 - Trigger mode = normal
 - Trigger source = Channel 1
 - Trigger coupling = dc
 - Slope = +
 - Perform full-stroke oscillating seek.
 - If using RK05 tester, set switches as shown below.
 - Mode = OSC
 - Cylinder address = 202
 - Function = RUN

NOTE

See Appendix B for detailed tester operation information.

- If using the oscillating seek program from Appendix C, perform the actions described below.
 - 11-Family CPUs: LOAD ADDRESS 001000
Set SWITCH REGISTER to 000312
Press START
 - 8-Family CPUs: LOAD ADDRESS 7000
Set SWITCH REGISTER to 3120
Press START
- If using the backplane jumper method, perform the steps listed below.
 - Set the drive select switch on the M7680/M7700 module (slot 2) to the first switch position.

- Select the drive by connecting a jumper from A08T1 (ground) to A08T2 (switch position one).
- Connect a jumper from the STROBE signal (B08H1) to the BUS SECTOR PULSE (B08N2).
- Connect a jumper string from SECTOR ADDRESS (A08P2) to the points given below.

```

A08H1 CYL ADD 7 (128)
A08E1 CYL ADD 6 (64)
A08C1 CYL ADD 3 (8)
A08D1 CYL ADD 1 (2)
-----
                202

```

- Install an M930 terminator in slot 7 or 9 of the RK05 logic chassis.
- If using the RK05 utility program, run the oscillating seek routine (TYPE = 2).
- Observe the full stroke waveform on the oscilloscope (see Figure PM-5).
- The duration of the waveform should be less than 90 milliseconds. If not, the servo system must be adjusted using the procedure in Appendix D.

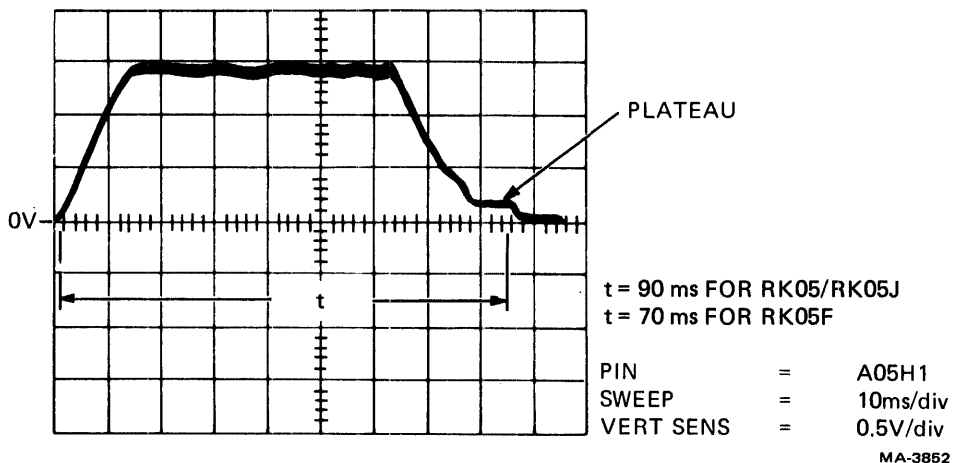

Figure PM-5 Full Stroke Profile Waveform

- Full stroke position waveform
 - Change oscilloscope gain control to 2V/cm.
 - Change channel 1 probe to A05M1.
 - The waveform should change to that shown in Figure PM-6.

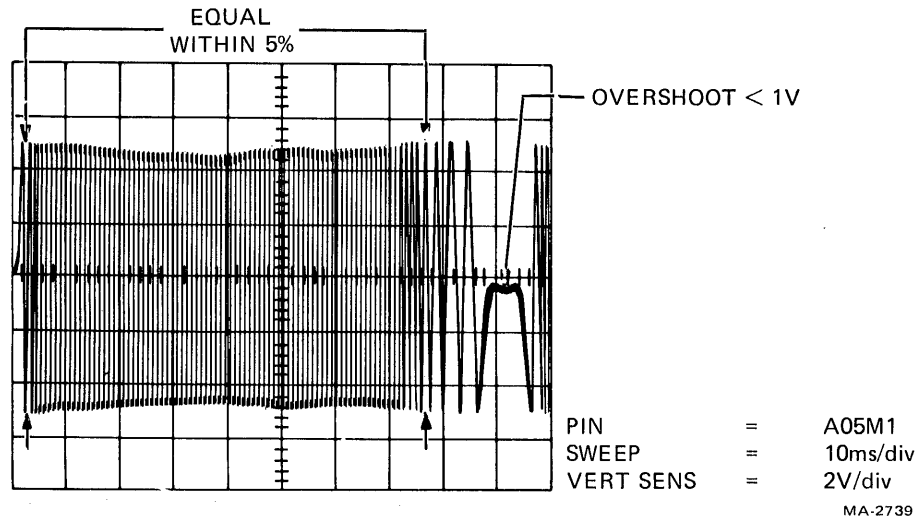

Figure PM-6 Full Stroke Position Waveform

- The waveform amplitude at the start of the seek should be within .25 cm (.5Vdc) of the waveform amplitude at the end of the seek.
- The waveform overshoot (at the end of the waveform) should not exceed 1V.
- If either of the above checks to the position waveform show out of tolerance, the servo system must be adjusted using the procedure in Appendix D.
- Restore the address select switch on the M7680/M7700 module to its original position unless continuing with this PM procedure.

17. SPINDLE RUNOUT CHECK

- Load the RK05-AC alignment cartridge into the drive.
- Write protect the drive.
- Load the heads and allow to run at least 30 minutes to allow temperature stabilization.
- Seek to cylinder 105.
- If using RK05 tester, set switches as shown below.
 - Cylinder address = 105
 - Mode = oscillate
 - Function = RUN

NOTE

The tester will perform an oscillating seek from zero to cylinder 105. To stop at cylinder address 105, set the function switch to run and then off. The tester will perform the oscillating seek routine and then stop. The carriage will have stopped at cylinder 105 or zero. Repeat, alternating the run switch to on and then off until the heads stop at cylinder 105.

- If using the oscillating seek program from Appendix C, perform the actions described below.
 - 11-Family CPUs: Change location 1062 from 205 to 000 (HALT).
LOAD ADDRESS 001000.
Set switch register to 000151.
Press START.
 - 8-Family CPUs: Change location 7026 from 5200 to 7402 (HALT).
LOAD ADDRESS 7000.
Set switch register to 1510.
Press START.
- If using the backplane jumper method, perform the steps listed below.
 - Connect a jumper from the STROBE signal (B08H1) to the BUS SECTOR PULSE (B08N2).
 - Connect a jumper string from an available ground pin (i.e. A07T1, A07C2, B07T1) to the points listed below.
 - A04V1 SEL RDY L
 - A08E1 CYL ADD 6 (64)
 - A08J1 CYL ADD 5 (32)
 - A08C1 CYL ADD 3 (8)
 - A08K1 CYL ADD 0 (1)

105
 - The drive address select switch on the M7680/M7700 module should be on the first switch position in order to select the drive.
 - An M930 terminator should be in slot 7 or 8 of the RK05 logic chassis.

- Connect oscilloscope as shown below.
 - Channel 1 = TP3 on G180 module
 - Sync = external
 - Sweep time = 10 msec/cm
 - Vertical sensitivity gain = .2V/cm (x10 probe) dc
 - Trigger mode = normal
 - Triggering = external, AC, level and slope controls to minus (-)
 - External trigger to A02R2 (INDEX PULSE)

The RK05K-AC alignment cartridge is now displaying a complete revolution of alignment data using the INDEX pulse as a trigger. If spindle runout exists, the read/write heads may appear to be aligned at some sector locations and misaligned at others. Figure PM-7 shows a display with negligible runout and the heads in alignment.

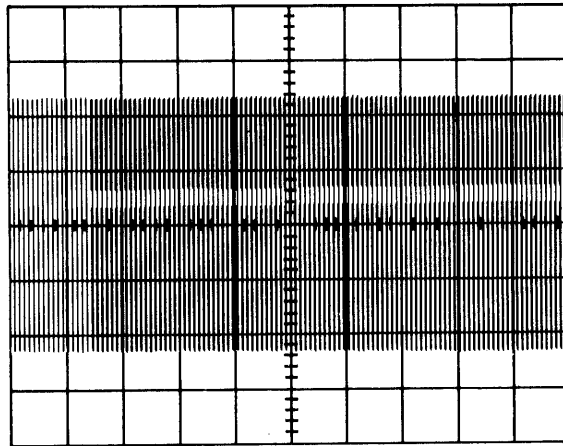

MA-3848

Figure PM-7 Negligible Runout

Figure PM-8 shows a display with considerable runout. Note the amplitude variations from one end of the display to the other. Head misalignment with no runout would show as a consistent pattern of two distinct amplitudes (such as that of the middle four centimeters of Figure PM-8).

- If spindle runout exists, the mating area of the spindle and disk should be cleaned, as dirt or other foreign matter can cause improper seating of the cartridge. Improper seating can give the appearance of spindle runout.

- Once the spindle and cartridge hub have been cleaned and the cartridge re-inserted, the runout should be checked again. If the runout pattern still exists, calculate the amount of runout using the formula below.

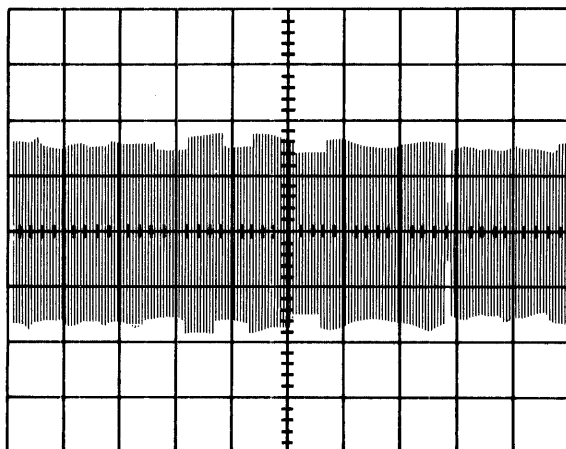

MA-3640

Figure PM-8 Considerable Runout

- $$\% \text{ of runout} = \frac{X - Y}{X + Y} \times 100$$

The maximum percentage of runout allowable is 14%.

- $$\text{Runout in microinches} = \frac{X - Y}{X + Y} \times 100 \times 135$$

The maximum amount of runout in microinches allowed is 500.

Runout Example

Using Figure PM-8 as an example:

$$\frac{3.8 - 2.8}{3.8 + 2.8} = \frac{1}{6.6} \times 100 = 15\%$$

$$\frac{1}{6.6} \times 100 \times 35 = 525 \text{ microinches}$$

- If runout is not acceptable, check again by removing the cartridge and rotating the disk 90 degrees within the cartridge casing. Reinstall the cartridge and check the waveforms once more. If the runout shown on the oscilloscope waveform shifted 90 degrees, then the runout is in the spindle. If the runout shown on the oscilloscope stays at the same relative position on the oscilloscope trace, then the cartridge is the source of the runout.

18. HEAD ALIGNMENT CHECK

- Using the same oscilloscope hook-ups, change the sweep time to 0.5 msec/cm. This reduces the presentation from a whole revolution to approximately one and a half sectors.
- Use the same formula as used in the runout check to complete the amount of head misalignment. The maximum percentage of head misalignment allowable is 15%. (See Figure PM-9 for head alignment waveform examples.)

a. Extreme misalignment. Head close to CYL 104. (Further misalignment only reduces amplitude of signal on right side of screen until it disappears.)

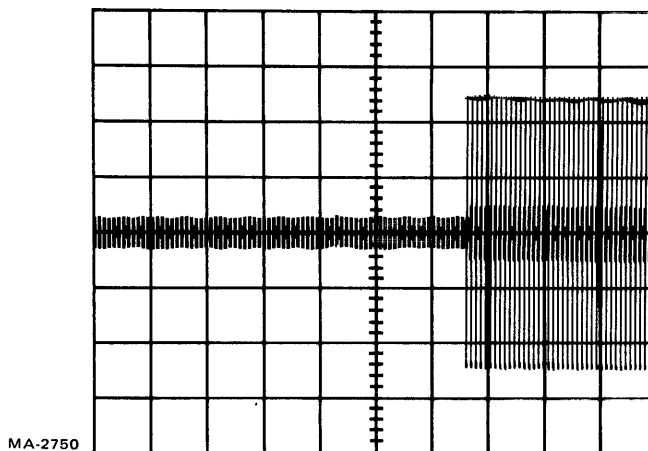

b. Head slightly misaligned. Smaller left amplitude indicates head position less than CYL 105.

Error = -15%

BRIGHT LINE SHOULD APPEAR HERE

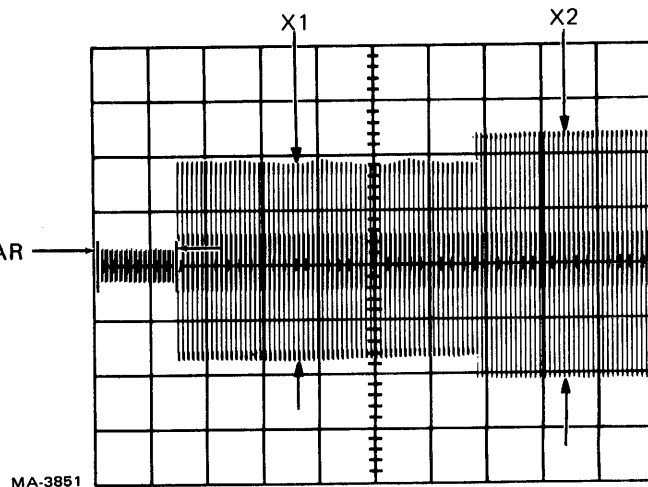
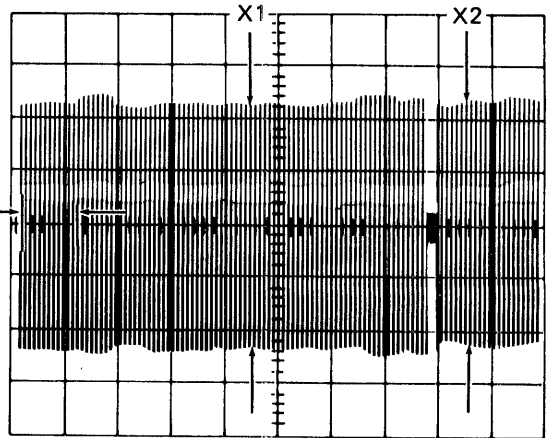

Figure PM-9 RK05K-AC Head Alignment Waveform (Sheet 1 of 3)

- c. Head correctly aligned at CYL 105. Amplitudes are equal.

BRIGHT LINE SHOULD APPEAR HERE



MA-3850

- d. Head slightly misaligned. Larger left amplitude indicates head position more than CYL 105.

Error = +15%

BRIGHT LINE SHOULD APPEAR HERE

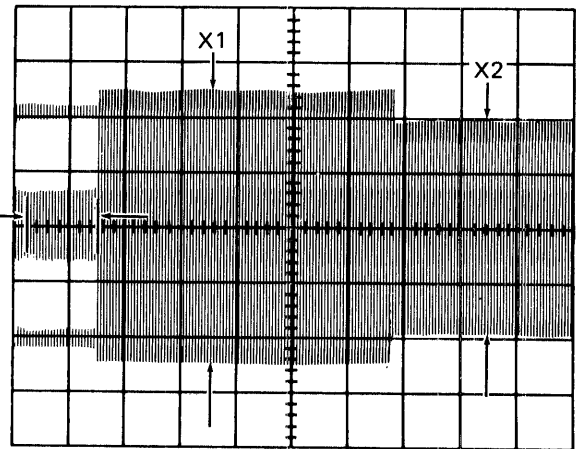

MA-3643

- e. Head considerably misaligned. Larger left amplitude indicates head position more than CYL 105.

Error = +72%

BRIGHT LINE SHOULD APPEAR HERE

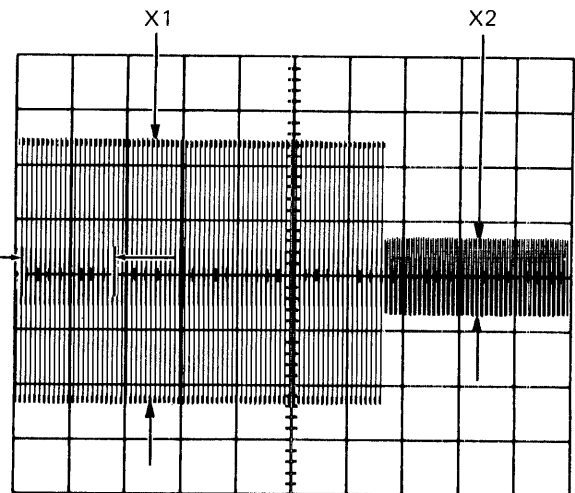

MA-3849

Figure PM-9 RK05K-AC Head Alignment Waveform (Sheet 2 of 3)

- f. Extreme misalignment. Head close to CYL 106. (Further misalignment only reduces amplitude of signal on left side of screen until it disappears.)

BRIGHT LINE SHOULD APPEAR HERE →

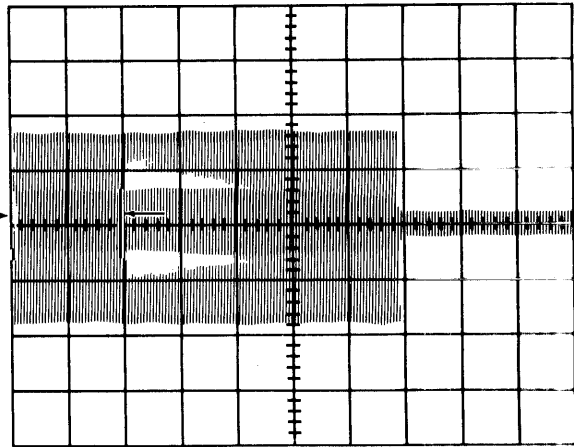

MA3810

Figure PM-9 RK05K-AC Head Alignment Waveform (Sheet 3 of 3)

To calculate percent of error, use the formula given below.

$$\% \text{ error} = \frac{X_1 - X_2}{X_1 + X_2} \times 100$$

X_1 and X_2 = amplitudes. The resultant sign denotes the direction of error; a negative (-) sign indicates that the head is back too far.

- Repeat procedure for the upper read/write head.
- Using a jumper, connect B07T2 (ground) to B08M2 (head select).
- If either read/write head is out of alignment, follow the procedure found in Appendix E to correct the misalignment.

19. INDEX/SECTOR TIMING DELAY CHECK

- Using same oscilloscope hook-ups as used in the head alignment procedure, change the sweep time to 10 microseconds/centimeter. This changes the oscilloscope display from a whole sector and a half to that of the very beginning of one sector.
- Measure the time difference between the start of the sweep (triggered on index pulse) and the first recorded pulse on the oscilloscope trace. Figure PM-10 shows this difference to be 70 microseconds.

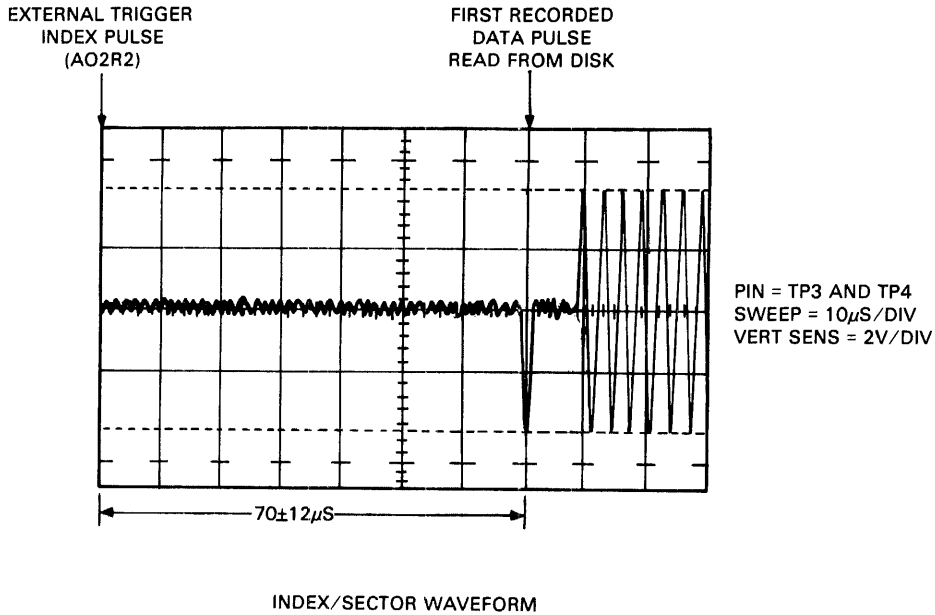

CZ-0293

Figure PM-10 Index/Sector Waveform

NOTE

The first recorded data pulse may be either a positive-going or a negative-going pulse.

- The tolerance of the time difference is 70 ± 12 microseconds. If the time difference is within tolerance, continue with the remainder of the check. If the time difference is out of tolerance, measure the time difference using the upper head to determine the amount of misalignment.
- Select the upper head by installing a jumper between ground and B08M2.
- Again, measure the time difference between the start of the oscilloscope sweep and the first recorded data pulse.
- The tolerance of the time measurement is 70 ± 12 microseconds. If the time difference is within tolerance, continue with the remainder of this check. If the time difference is out of tolerance, compute the average of the two measurements.

To compute the average, add the measurement taken from the upper head to the measurement taken from the lower head, and divide by two.

- The average of the two measurements must be 70 ± 10 microseconds. If the average is within this specification, go on to the next check. If the average is out of this specification, go to Appendix F, Step 10, for the procedures to correct the misalignment.
- Both heads should be within the individual specification while meeting the average of two heads specification.
- If check is out of tolerance for either specification, refer to Appendix F for procedures to correct the misalignment.
- Return the drive address select switch to its original position.

20. READ DATA SEPARATOR CHECK

- Remove the alignment cartridge and insert a known good formatted scratch cartridge.
- Using the maintenance switch (S1 on the H604 module), manually position the heads at any recorded cylinder past zero.

NOTE

Allow the heads to load under logic control, then place a finger on the carriage while opening switch S1. This will preclude the possibility of carriage motion caused by transient switch noise.

- Set up the oscilloscope as shown below.
 - Mode = channel A
 - Vertical sensitivity = 1V/div
 - Trigger source = Channel A
 - Trigger coupling = dc
 - Sweep time = 100 ns/div
 - Trigger mode = normal
 - Coupling = ac
 - Slope = positive
 - Connect channel A probe to TP1 of the G180 module (slot 1)

- The oscilloscope waveform should be a positive-going pulse 440 (± 10) nanoseconds in length.
 - If the pulse length is not within this specification, go to Appendix G and start with Step 4 of that procedure.
21. RUN DZRKL-E RK11/RK05 DYNAMIC TEST OR DHRKB-G-D RK8-E DRIVE CONTROL TEST TO VERIFY THE ELECTROMECHANICAL INTEGRITY OF THE DRIVE.

APPENDIX A

8 TO 20 V (+15 V) REGULATOR ADJUSTMENT PROCEDURE

CAUTION

Care should be taken not to short the regulators to the chassis or to each other during this procedure.

NOTE

Use this adjustment only if RK05 FCO 00064 (5409484-00005) has been installed or regulators are of CS REV H or higher. While performing this adjustment, the regulators you are adjusting should be connected while all other regulators should be disconnected. Keep all modules installed to provide normal loading conditions.

+15 V REGULATOR ADJUSTMENT

1. Locate the +15 V regulator, remove it from the drive and separate it as shown in Figure A-1, so R2 can be adjusted.

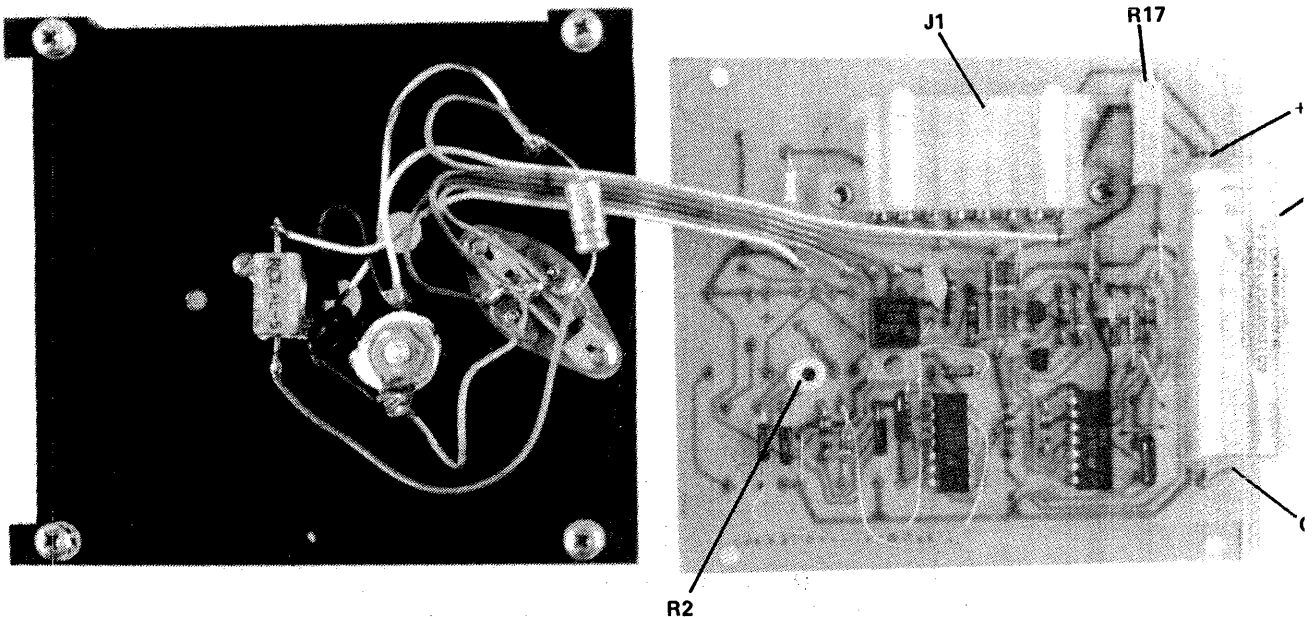

7911-1

Figure A-1 8-20 Volt Regulator

2. Turn R2 fully counterclockwise and apply power to the drive unit.
3. While observing +15 V on pin A01D2 (pin with large orange wire), adjust R17 for 17.0 V \pm 0.5 Vdc. Do NOT exceed 17.5 V.

4. Oscilloscope Settings

Gain (dc)	= 0.1 V/cm	"A" triggering mode	= NORMAL
AC coupled		"A" sweep mode	= NORMAL
Sweptime	= 20 μ s/cm	Mode trigger	= CH1

Place the probe on the (+) side of C4 and the probe ground on the (-) side. Refer to Figure A-2.

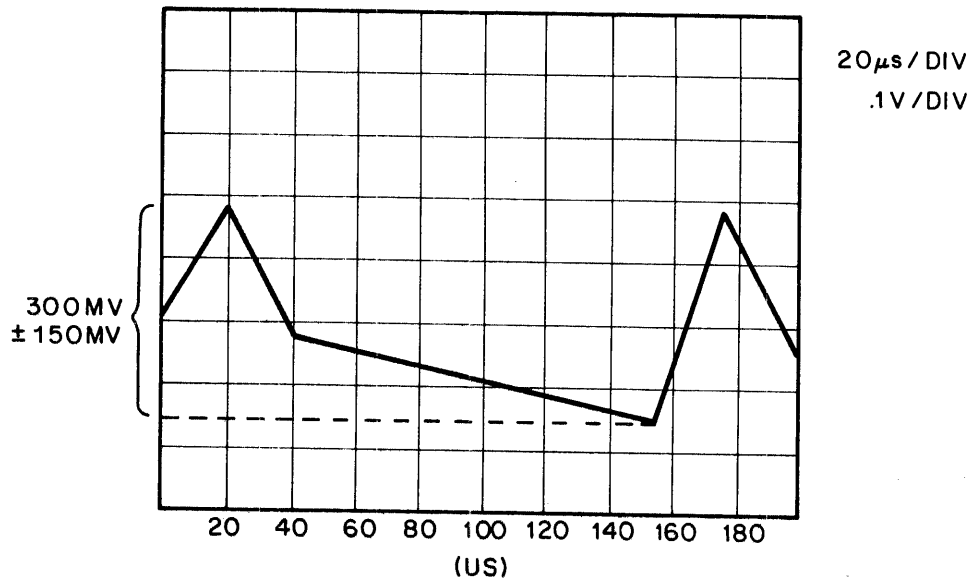

CP-2326

Figure A-2 C4 Waveform

5. Adjust R2 clockwise until the signal jumps off the screen. This is the condition for which you are adjusting R2, as the second overvoltage regulator (E1) begins to operate.

NOTE

DO NOT adjust the potentiometer any further than necessary because of excessive peak to peak ripple. Replace any voltage regulator that exceeds 250 millivolt ripple (p-p).

6. Reduce the gain of the oscilloscope, and the signal should resemble Figure A-3.
7. Adjust R17 for a +15 V signal on the scope. Power down the drive, assemble the regulator and mount it back on the drive.

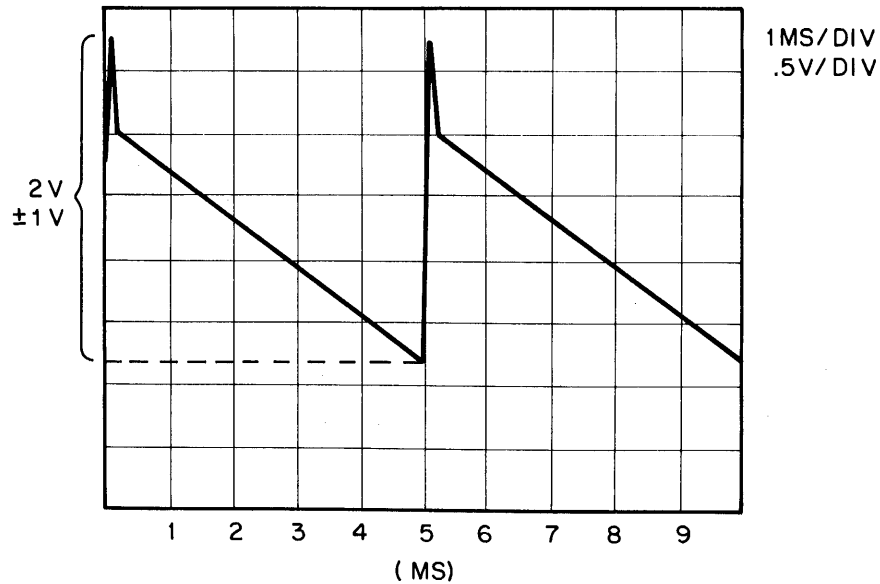

Figure A-3 Gain Waveform

-15 V REGULATOR ADJUSTMENT

1. Locate the -15 V regulator, remove it from the drive and separate it as shown in Figure A-1 so R2 can be adjusted.
2. Turn R2 fully clockwise and apply power to the drive.
3. While observing -15 V on pin A01B2 (pin with large blue wire), adjust R17 for $-17.0 \text{ V} \pm 0.5 \text{ Vdc}$. DO NOT exceed 17.5 V.
4. Set the oscilloscope as shown below.
 - Gain (dc) = 0.1 V/cm
 - Coupling = ac
 - Sweep = 1 msec/cm
 - A triggering mode = normal
 - A sweep mode = normal
 - Mode trigger = CH1

Place the probe on the negative (-) side of C4 and probe ground on the positive (+) side. Refer to Figure A-2.

NOTE

Figure A-2 represents the +15 V regulator waveform. Thus, the -15 V regulator waveform will be inverted.

5. Adjust R2 counterclockwise until the signal jumps off the screen. This is the condition for which you are adjusting R2, as the second overvoltage regulator (E1) begins to operate.

NOTE

DO NOT adjust the potentiometer any further than necessary because of excessive peak to peak ripple. Replace any voltage regulator that exceeds 250 millivolts of ripple (p-p).

6. Reduce the gain of the oscilloscope, and the signal should resemble an inverted form of Figure A-3.
7. Adjust R17 for a -15 V signal on the oscilloscope. Power down the drive, assemble the regulator and mount it back in the drive.

APPENDIX B
THE RK05-TA OFF-LINE TESTER

MOVE FUNCTIONS

1. STEP - incrementing cylinder seek to limit and a high-speed return.
2. ALT (alternate) - an incrementing seek from the cylinder address selected.
3. OSC - oscillate between 0 and the cylinder address selected (not affected by FOR/REV).
4. RAND - random cylinder seek.
5. DRIVE SELECTOR - selects the drive number selected on the M7700/M7680 module in the RK05.
6. RUN - enables all move functions.
7. RTZ - forces a zero recalibrate.
8. FWD/REV - selects the initial drive motion in step and alternate.
9. CYLINDER ADDRESS - selects any cylinder address from 0 to 202₁₀.

INDICATORS

1. ADDR INV - drive has detected that address switches are set to an address greater than 202.
2. SEEK INC - failure to move the correct number of cylinders in a seek operation. Excess time to perform the seek.
3. POWER ON - indicates power is applied to the drive.

WRITE FUNCTIONS

1. *WRITE SECTOR - selects a sector (0-7) to write on. ALL writes all sectors. The unit cannot read to check headers.
2. HEAD SELECT - selects or enables the upper or lower head.
3. *WRITE button - causes a write one-shot to write or erase on sector selected.

*After the RK05-TA has been used to perform write or erase operations, the disk will have to be reformatted.

4. *CONSTANT WRITE - when set, writes continuously on the sector selected; the WRITE button need not be pressed.
5. *DC ERASE on - enables erase on a sector when the WRITE button is pressed.
6. DATA BITS - sets a 4-bit data pattern to be written on the sector selected.

CONNECTING THE RK05-TA OFF-LINE TESTER TO THE RK05 DISK DRIVE

1. Disconnect the ac line cord.
2. Remove the interface cable from the RK05.
3. Check the RK05 and the tester to ensure that an M930 terminator module is present in slot 7 or 8 of the RK05, and slot 1 or 2 of the tester.
4. Connect a BC11-A cable from slot 1 or 2 of the tester to slot 7 or 8 in the RK05.
5. Disconnect connector J1 in the RK05 (logic voltage connector).
6. Plug one end of the tester power cable into the tester.
7. Check for proper keying of the pins and plug the male connector of the power cable into the female connector of J1.
8. Connect the remaining connector to the plug leading to the logic block of the RK05.
9. Reconnect the ac line cord.
10. Toggle RTZ to initialize and clear all error conditions and proceed with testing.

*After the RK05-TA has been used to perform write or erase operations, the disk will have to be reformatted.

APPENDIX C
RK05 MAINTENANCE PROGRAMS

PDP-11 FAMILY

The following program may be used in place of the jumper method or tester method while performing RK05 maintenance.

Track Address

Decimal	Octal
0	0
4	4
64	100
85	125
105	151
125	175
202	312

PDP-11 Oscillating Seek Program

The PDP-11 program listed later in this appendix is a handy aid when checking the servo signals or performing head alignment. After toggling in the program and patching the drive unit number, the program will cause the drive to seek back and forth between the cylinder addresses set in the left and right bytes of the switch register. Setting the same cylinder address in both bytes will make the drive stay on that cylinder.

General Operating Instructions

1. Toggle program instructions into switch register starting at location 1000.
2. Toggle registers R0-R6 with values shown in program.
3. Toggle the drive unit number into bits 15-13 of location 1032; XX0000 will select drive XX, surface 0; XX0020 will select drive XX, surface 1.
4. If error checking or other changes are to be added, change the NOPs in location 1050 and 1052 to jump to (ADDITIONAL) code address. Jump back to location 1054 at the end of added code.
5. Load address 1000; start.
6. Set desired cylinder addresses (0-312) into the left and right bytes of the switch register.
7. Leave zeros in the left byte of the switch register (switches 9-17) while performing servo adjustments. Seeks of 2, 4, 64, and 202 (decimal) cylinders may then be accomplished by setting octal 2, 4, 100, and 312 into the right byte of the switch register.

NOTE

Exceeding octal 312 in either switch register byte will require a program restart unless error code has been added (see Step 4).

8. Setting the same cylinder address in both bytes will result in continuous seeks to that address.
9. This program may be modified using the CORE and MOD commands of the UPDATE program. UPDATE may also be used to output the modified version of any program to DECTape, DECpack or DEC papertape.
10. Repetitive RESTORES may be accomplished by changing location 1060 from 011 to 015.

RK05 OSCILLATING SEEK PROGRAM

STARTING ADDRESS 1000

DISK ADDRESS (15-13)
 CHANGE LOCATION 1032 IF
 DISK IS OTHER THAN DRIVE
 ZERO

GENERAL REGISTER USE

R0	0
R1	177570 (SR)
R2	1014 (SUBROUTINE)
R3	177404 RKCS
R4	177412 RKDA
R5	JSR 0
R6	4000 STACK POINTER

1000	11100	MOV SR, R0	START
	300	SWAB, R0	
	4512	JSR, (R2)	
	11100	MOV SR, R0	
	4512	JSR, (R2)	
1012	772	BR, START	
1014	241	CLC	SUBROUTINE
	42700	BIC	MASK OUT LOWER BYTE
	377	*	MASK OUT LOWER BYTE
	6000	ROR	ROTATE SR DATA INTO CYLINDER
	6000	ROR	ADDRESS SLOT
	6000	ROR	
1030	62700	ADD DA, R0	
	XX0000	*	XX = DISK ADD (15-13)
1034	105713	TSTB	RKCS
	100376	BPL	BRANCH IF CONTROLLER IS BUSY
	32737	BIT	
	100	*	MASK (ACCESS READY)
	177400	*	RKDS
1046	1774	BEQ	BRANCH IF NOT READY
1050	240	NOP	JUMP MAY BE INSERTED FOR
1052	240	NOP	MODIFICATION
1054	10014	MOV R0, RKDA	
	12713	MOV 11, RKCS	(SEEK AND GO)
	11	OR 15, RKCS	(RESTORE AND GO)
1062	205	RTS	

PDP-8 FAMILY

The following program may be used in place of the jumper method or tester method while performing RK05 maintenance.

This simple manual-entry program can be used when performing servo adjustments or head alignment. The program is continuously running, so changes to the operation of the drive can be made simply by changing the switches.

ALIGNMENT PROGRAM LISTING

Location	Code	Mnemonic
0004	7604	LAS
0005	7430	SZL
0006	0006	ANDK6
0007	0007	ANDK7
0010	1025	TAD COMMAND
0011	6746	DLDC
0012	7420	SNL
0013	7604	LAS
0014	6743	DLAG
0015	6741	DSKP
0016	5015	JMP-1
0017	7604	LAS
0020	0026	ANDK10
0021	7450	SNA
0022	7120	STL
0023	7020	CML
0024	5004	JMP 0004
0025	3200	COMMAND = SEEK AND SET DONE ON SEEK DONE
0026	0010	K10

SWITCH REGISTER BIT FUNCTION

The list that follows shows the switch register bits that control the above program.

Switch Register Bits	Description
0-6	Contain cylinder address
7	1 = upper surface, 0 = lower surface
8	0 = seek to cylinder
9-10	Select the drive (0 - 3)
11	Most significant cylinder address bit

PROGRAM OPERATION

1. Load address 0004.
2. Set SWITCH REGISTER to desired binary cylinder address in bits 0 - 6; desired surface in bit 7, drive unit number in bits 9-10, and most significant cylinder address bit in bit 11.
3. Press the CLEAR, then the CONT switches.

APPENDIX D
RK05 SERVO ADJUSTMENTS

STATIC ADJUSTMENTS

The following procedures should be performed when the positioner or a major servo system component has been replaced. These procedures should also be followed as an aid when the positioning system is so unstable that the dynamic alignments of the servo cannot be performed.

In general, to make the static adjustments, the cartridge is removed and the positioner moved back and forth by hand. The oscilloscope should be on automatic sweep while observing the selected signal. With some practice, the most convenient sweep speed setting and the type of hand motion required will quickly be discovered.

NOTE

Table D-1 shows the physical location of the adjustment potentiometers on the G938 module. They are listed in the order that they appear on the module, i.e., V0 is the bottom-most potentiometer. Access to the potentiometers may be gained by removing the prefilter on the back of the drive.

Table D-1 Location of Servo System Adjustment Potentiometers

G938 Module

CA
CO
SA
SO
LSA
LSO
VA
VO

1. Sine Amplitude (SA) and Offset (SO)
 - Set the oscilloscope vertical sensitivity to 2 V/div and adjust the ground reference to the center of the screen.
 - Connect channel A probe to A05M1 (SIN POSITION)
 - While holding the carriage assembly steady, place the red maintenance switch (S1) on the H604 module down (off). The H604 module is located in the left rear corner of the drive directly opposite the relay module.

CAUTION

Before performing the following steps, place a wrung-out alcohol wipe between the heads to protect them.

- Manually move the positioner back and forth.
 - Adjust SA for a 10 volt peak-to-peak amplitude display.
 - Adjust SO for a peak-to-peak display that is centered about the ground reference of the oscilloscope display.
2. Cosine Amplitude (CA) and Offset (CO)
- Connect channel A probe to A05S1 (COS position).
 - Manually move positioner back and forth.
 - Adjust CA for a 10 volt peak-to-peak amplitude display.
 - Adjust CO for a peak-to-peak display that is centered about the ground reference of the oscilloscope display.
3. Limit Signal Amplitude (LSA) and Offset (LSO)
- Change the oscilloscope vertical sensitivity to 1 V/div and adjust the ground reference to the center of the screen.
 - Connect channel A probe to A05J1.
 - Move the positioner to the approximate center of travel.
 - Adjust LSO for a ground signal at the center of the screen.
 - Move the positioner to the inner limit while observing the maximum amplitude of the oscilloscope display. Will be a negative voltage.
 - Move the positioner to the outer limit while observing the maximum amplitude of the oscilloscope display. Will be a positive voltage.
 - Adjust LSA until the smaller of the two voltage levels noted is a 3.0 volt potential.
 - Return the positioner to the center of travel and readjust LSO for 0 volt.

- Again move the positioner to the inner limit while observing the change to the oscilloscope display.
- Again move the positioner to the outer limit while observing the change to the oscilloscope display.
- Readjust LSA until the smaller voltage level noted is 3.0 volt potential.
- Return the maintenance switch to the up (on) position.

Performing these static adjustments should enable the drive to operate well enough to perform the dynamic servo adjustments.

DYNAMIC ADJUSTMENTS

In performing this series of adjustments, either the off-line tester or the RK05 utility program can be used to perform the various oscillating seeks required to perform the adjustments. If neither are available, Appendix C contains a manual-entry program that can be utilized to perform the seeks on-line.

If the drive cannot be used on-line, and a tester is not available, then the backplane jumper method must be used.

With this method, backplane jumpers are used to initiate the seeks. SECTOR pulses are jumpered to simulate STROBE pulses, and a SECTOR ADDRESS line is jumpered to the required CYLINDER ADDRESS lines. With these jumpers in place, oscillating seeks may be performed between cylinder 00 and the jumpered cylinder address.

1. Preliminary drive set-up

- Unplug the AC line cord.
- Install an M930 terminator in slot 7 or 8 of the RK05.
- Set the address select switch on the M7680/M7700 module to the first switch position.
- Connect a jumper from A08T1 (ground) to A08J2 (switch position 1) selecting the drive.
- Reconnect the AC line cord.
- Cycle the drive up to operating status.
- Load a scratch cartridge into the drive.
- Press the RUN switch, loading the heads.
- Connect a jumper from B08H1 (STROBE) to B08N2 (BUS SECTOR PULSE).

2. Sine Amplitude (SA) and Offset (SO)

- Enable the drive to perform a four cylinder oscillating seek. If using the jumper method, connect a jumper from A08P2 (SECTOR ADDRESS) to A08L1 [CYLINDER ADDRESS 2 (4)].
- Connect channel A probe to A05M1 (SIN POSITION).
- Connect external trigger probe to B05j2. Leave this probe in reach for all servo adjustments.
- Observe a waveform similar to that shown in Figure D-1(a).
- Adjust SA for a display amplitude of 10 volt \pm 1 volt peak-to-peak.
- Adjust SO for a display signal that is centered about the ground reference of the scope (symmetrical about ground). When correct, the waveform peaks should look like those in Figure D-1(a) and (b).

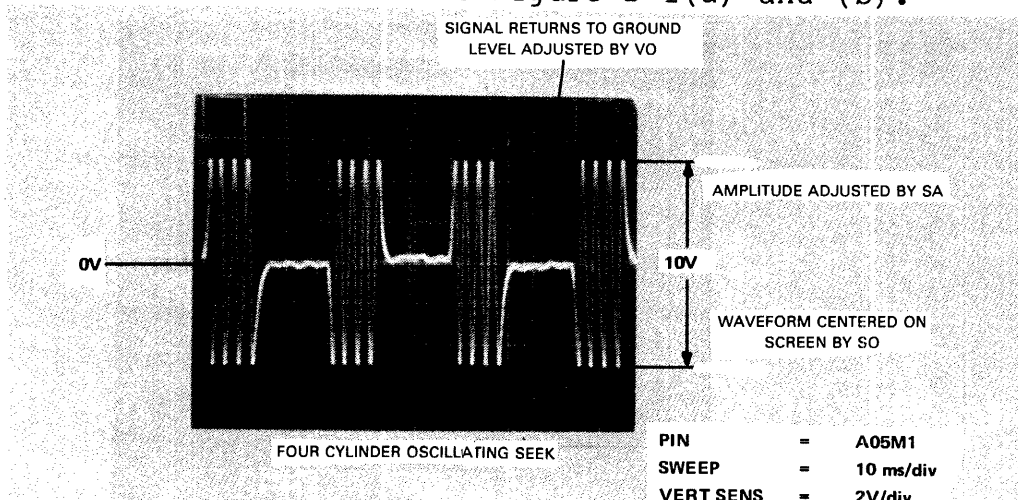

(a) Correct Waveform (Symmetrical Signal)

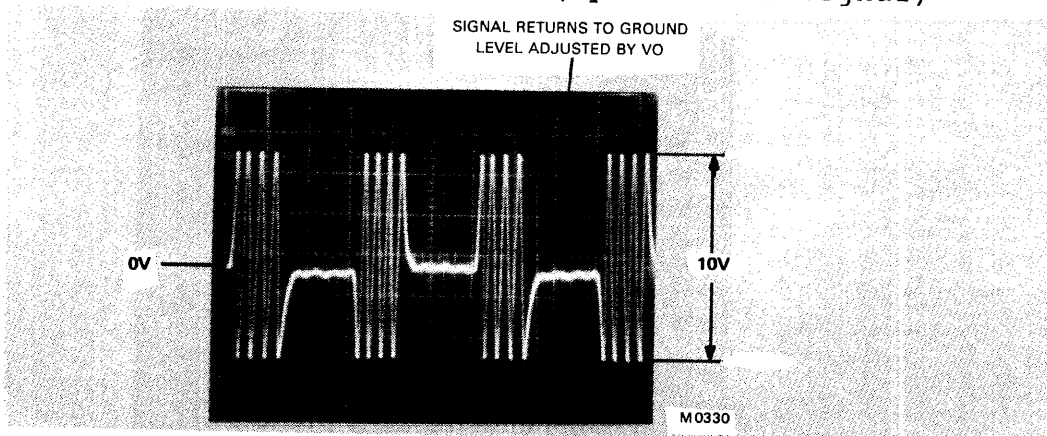

(b) Incorrect Waveform (Signal Not Symmetrical About Ground)
Figure D-1 Sine Amplitude/Offset and Velocity Offset Waveform

NOTE

At this time, disregard those portions of the waveform between the four sinusoidal peak bursts. The next adjustment corrects this misalignment.

3. Velocity Offset (VO)

- Using the same jumpers and oscilloscope hook-ups, adjust VO to center the voltage minimums about a ground reference. (See the circled areas on Figure D-1 (a) and (b).)

4. Cosine Amplitude (CA) and Offset (CO)

- Change channel A probe to A05S1 (COS POSITION).
- Observe a waveform similar to that shown in Figure D-2.

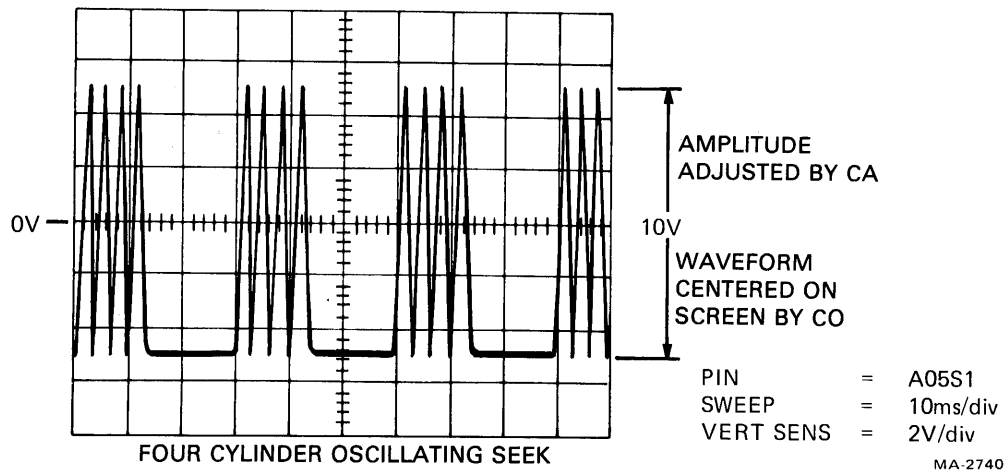

Figure D-2 Cosine Amplitude/Offset Waveform

- Adjust CA for a 10 volt ± 1 volt peak-to-peak amplitude signal.
- Adjust CO for a waveform that is centered about the ground reference of the scope (symmetrical about ground).

5. Velocity Amplitude (VA)

- Enable the drive to perform a two cylinder oscillating seek. If using the jumper method, connect a jumper from A08P2 (SECTOR ADDRESS) to A08D1 [CYLINDER ADDRESS 1 (2)].
- Change the oscilloscope sweep time to 1 millisecond/division.

- Connect channel A probe to A05M1.
- Observe a waveform similar to that shown in Figure D-3.

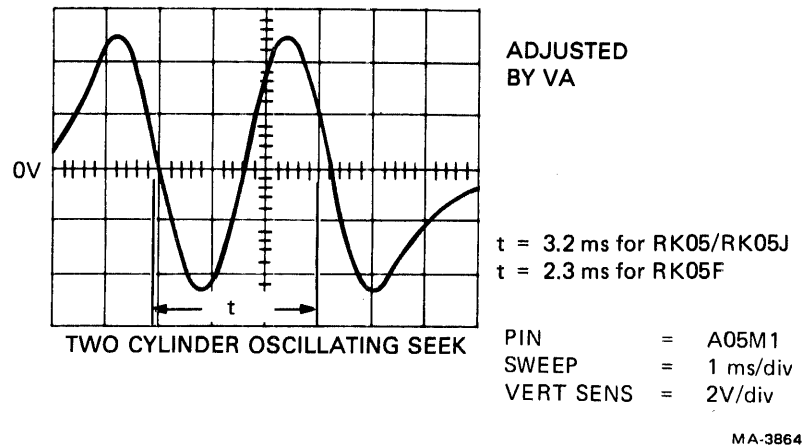

Figure D-3 Velocity Amplitude Waveform

- Adjust VA for a one-cycle time period of $3.2 \pm .05$ milliseconds ($2.3 \pm .01$ milliseconds if adjusting an RK05F).

NOTE

This measurement must be taken from the center cycle of the waveform as shown in Figure D-3.

6. Positioner Acceleration (Current)

- Enable the drive to perform a 64 cylinder oscillating seek (128 cylinder seek if adjusting an RK05F). If using the jumper method, connect a jumper from A08P2 (SECTOR ADDRESS) to A08E1 [CYLINDER ADDRESS 6 (64)].
- Change the oscilloscope sweep to 5 milliseconds/division.
- Change the oscilloscope vertical sensitivity to 0.5 V/division.
- Connect channel A probe to A05H1 (VELOCITY).
- Observe a waveform similar to that shown in Figure D-4.
- Adjust R15 on the H604 module to obtain a time period of 14 ± 1 milliseconds (13 ± 1 milliseconds if adjusting an RK05F).

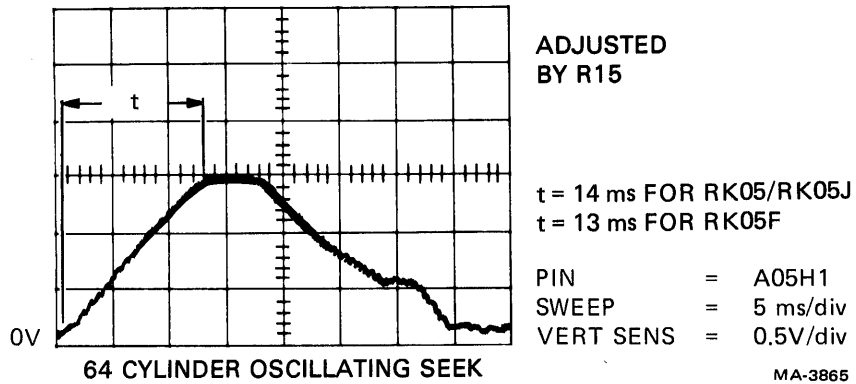

Figure D-4 Acceleration Waveform

7. Full Stroke Profile Check

- Enable the drive to perform a 202 cylinder oscillating seek. If using the jumper method, connect a jumper string from A08P2 (SECTOR ADDRESS) to the points listed below.
 - A08H1 [CYLINDER ADDRESS 7 (128)]
 - A08E1 [CYLINDER ADDRESS 6 (64)]
 - A08C1 [CYLINDER ADDRESS 3 (8)]
 - A08D1 [CYLINDER ADDRESS 1 (2)]

202
- Change the oscilloscope sweep to 10 milliseconds/division.
- Change the oscilloscope vertical sensitivity to 0.5 V/division.
- Connect channel A probe to A05H1 (VELOCITY).
- Observe a waveform similar to Figure D-5.
- The full-stroke signal must conform to the specifications listed below.
 - The time period (from the start of the waveform until it reaches 0 volt must be less than 90 milliseconds (70 milliseconds if adjusting an RK05F).
 - The plateau must be smooth (without ripple).

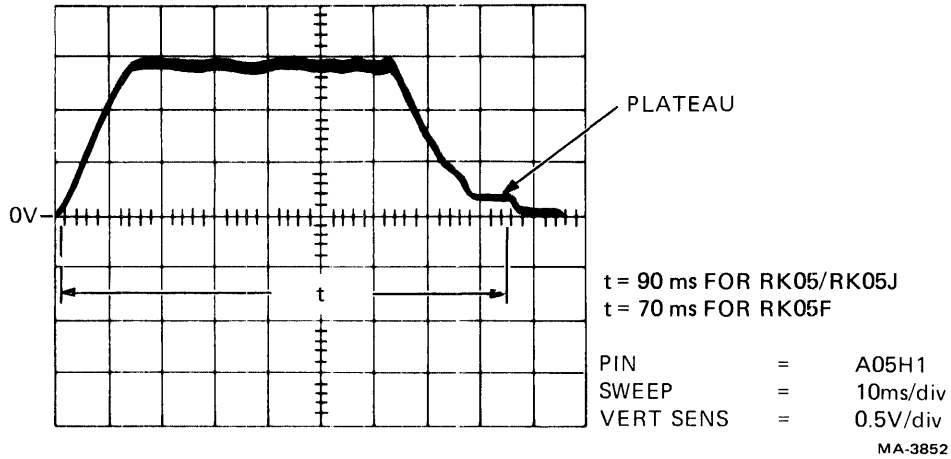

Figure D-5 Full Stroke Waveform

- If either condition listed above cannot be met, then the VA and R15 (positioner current) adjustments must be re-checked. If, after readjusting the velocity amplitude and positioner current, the specifications cannot be met, then something is probably wrong with the positioner assembly, i.e., flat-spotted bearings, dirt in the guides, etc.

8. Full Stroke Position Waveform Check

- Perform the full stroke profile check.
- Change the oscilloscope vertical sensitivity to 2 V/division.
- Change channel A probe to A05M1 (SIN POSITION).
- Observe a waveform similar to Figure D-6.

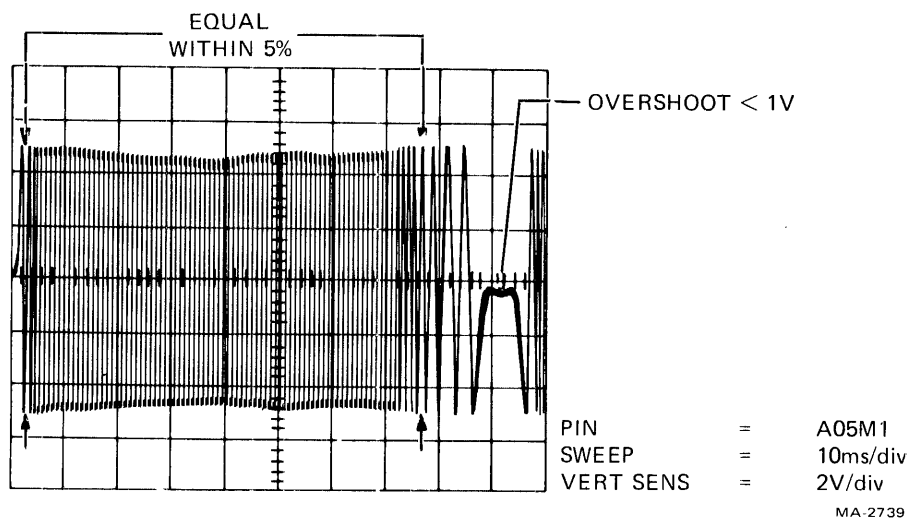
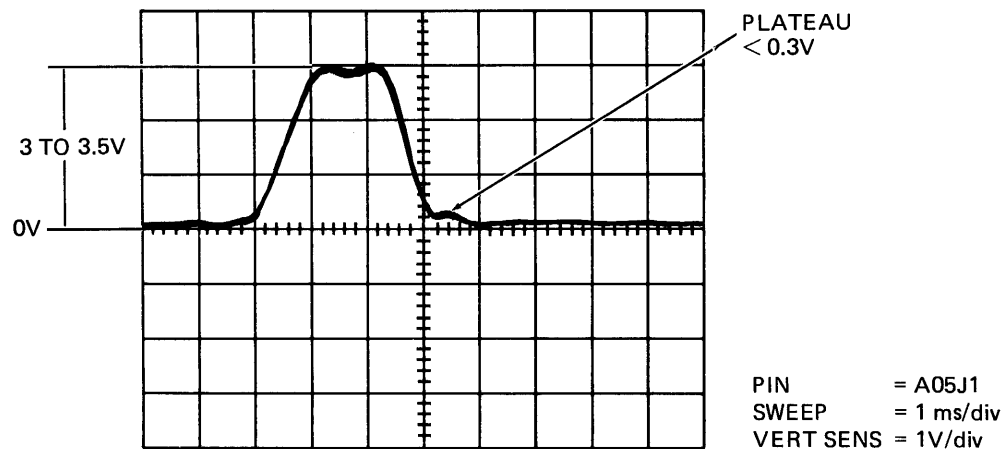

Figure D-6 Full Stroke Position Waveform

- The full-stroke position signal must conform to the specifications listed below.
 - The waveform amplitudes at the start and end of the seek display must be equal, $\pm 5\%$.
 - The waveform overshoot at the end of the seek display must not exceed 1 volt.
- If either condition listed above cannot be met, then the VA and R15 (positioner current) adjustments must be re-checked. If, after readjusting the velocity amplitude and positioner current, the specifications still cannot be met, then something is probably wrong with the positioner assembly, i.e., flat-spotted bearings, dirt in the guides, etc.

9. Outer Limit Signal Check

- Remove all jumpers except A08J1 to A08J2.
- Enable the drive to perform a repetitive restore operation. If using the jumper method, connect a jumper from A08M1 (RESTORE) to A07T1 (or any available ground). Connect another jumper from B08H1 (STROBE) to B08M1 (INDEX).
- Connect an oscilloscope external trigger to B05K2 (REV H).
- Change the oscilloscope vertical sensitivity to one volt/division.
- Connect channel A probe to A05J1 (LIMIT).
- Observe a waveform similar to Figure D-7.



MA-3641

Figure D-7 Outer Limit Waveform

- The limit signal must conform to the specifications listed below.
 - The pulse amplitude must be in the range of 3 to 3.5 volt.
 - The waveform minimum amplitude must drop to 0 volt.
 - The plateau on the trailing edge must not exceed 0.3 volt.
- If the above specifications cannot be met, the static limit adjustment must be performed.

10. Inner Limit Signal Check

- Perform the outer limit signal check.
- Disconnect the jumper on B08H1 (STROBE) to halt the repetitive restore operation.
- Using switch S1 on the H604 module, manually move the positioner toward the spindle until inner limit is sensed. If the inner limit signal is operative, a restore operation will be initiated.
- If no restore operation was initiated, perform the static limit adjustment procedure.

APPENDIX E RK05 HEAD ALIGNMENT PROCEDURES

INTRODUCTION

This procedure is divided into the five stages described below.

1. The preliminary drive set-up describes initial drive and oscilloscope preparation and assumes that the backplane jumper method is to be used to perform the seeks.
2. The positioner track scale alignment section describes checking that the track scale can be read accurately by the person performing the head alignment. If the scale is out of alignment, procedures are given to correct it. This procedure can be performed while waiting for the drive to warm up.
3. The seek to the alignment cylinder section describes the procedures required to make a drive move the heads to the alignment cylinder. This procedure covers only the backplane jumper method of seeking.
4. The head waveform check shows sample head alignment waveforms and describes how to determine the amount of misalignment by viewing an oscilloscope trace.
5. The head alignment procedures describe what to do once it has been determined that one or both of the heads require alignment.

GENERAL INFORMATION

- Before attempting head alignment, ensure that the drive operates correctly, and that the heads are not contaminated.
- The RK05-AC alignment cartridge replaces the older IBM 2315 alignment cartridge as the cartridge with which to perform the alignment.
- Align heads only if they are off by 15% or more.
- The positioner may be moved to the alignment cylinder by any of four different methods.
 - Manual-entry program routines (Appendix C)
 - RK05 utility program (DZRKI)
 - RK05-TA Tester
 - Backplane jumper method

DRIVE PRELIMINARY SET-UP

- Unplug the ac line cord.
- Disconnect the drive interface cable from the drive logic.
- Install an M930 terminator in its place.
- Reconnect the ac line cord.
- Load an RK05-AC alignment cartridge.
- Press the RUN switch to load the heads.
- Allow the cartridge and drive to thermally stabilize for at least 30 minutes before attempting alignment.

NOTE

Thermal stabilization is extremely important to the accuracy of the alignment. Do not bypass or shortcut this step.

- Press the WRITE PROTECT switch to ensure that the alignment cartridge cannot be accidentally written on.
- Set-up oscilloscope as shown below.
 - Vertical mode = channel A
 - Vertical sensitivity = 20 millivolts/division
 - Vertical coupling = dc
 - Sweep time = 0.5 milliseconds/division
 - Trigger source = external
 - Trigger mode = normal
 - Trigger coupling = ac
 - Connect a x10 probe from channel A to TP3 of the G180 module
 - Connect a x10 probe from the external trigger to A02R2

POSITIONER TRACK SCALE ALIGNMENT

While the cartridge and drive are achieving stabilization, the track scale can be checked for accuracy and aligned if necessary.

- Read the track scale. With the heads loaded, the scale should be at 00.
- If the track scale does not read 00, perform the steps listed below.
 - Loosen the scale retaining screws (see Figure E-1).

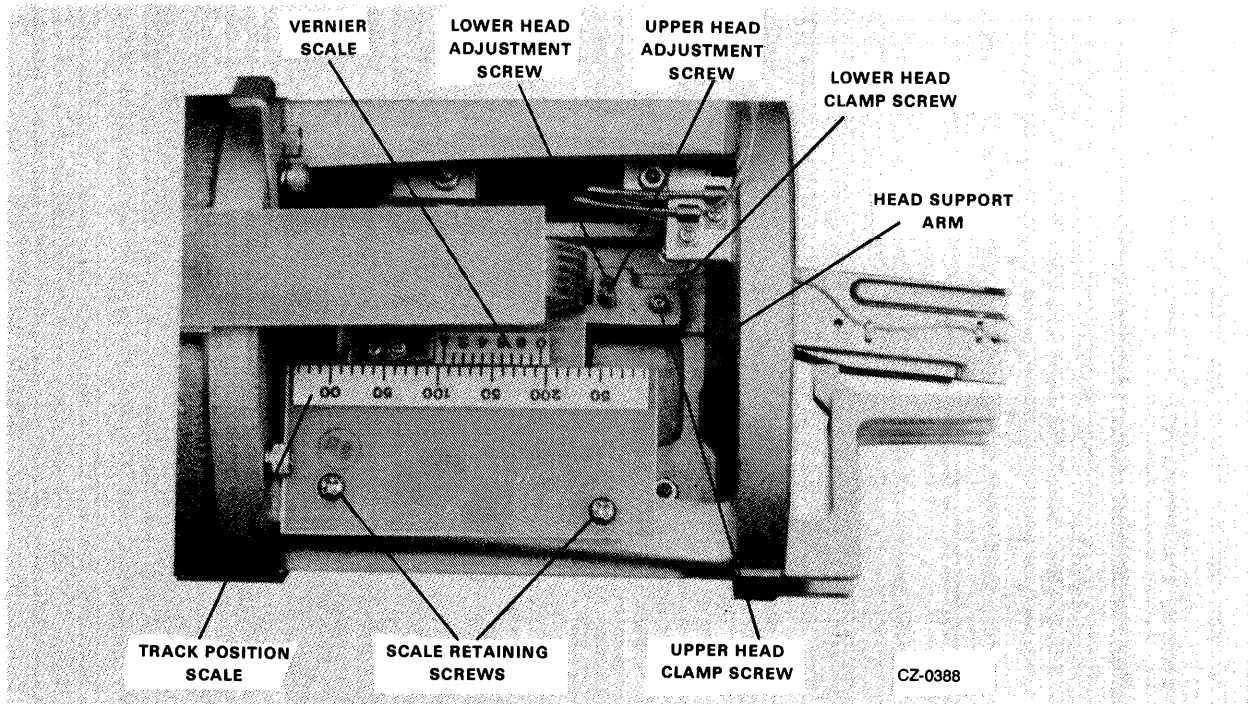

Figure E-1 Location of Scale Retaining Screws

- Adjust the position track scale to 00.
- Ensure that the vernier scale (Figure E-1) and the positioner scale do not touch and are parallel to each other.
- Tighten the retaining screws.
- Push the maintenance switch (S1) on the H604 module down (off).
- Move the positioner gently through its entire range of travel ensuring that the two scales do not touch at any point.
- If the scale reads 00, continue with the thirty minute stabilization period. When completed, proceed with the following.

SEEK TO THE ALIGNMENT CYLINDER (RK05/RK05J)

- Using the backplane jumper method, connect a jumper string from A07T1 (or any available ground) to the points listed below.
 - A08E1 [CYLINDER ADDRESS 6 (64)]
 - A08J1 [CYLINDER ADDRESS 5 (32)]
 - A08C1 [CYLINDER ADDRESS 3 (8)]
 - A08K1 [CYLINDER ADDRESS 0 (1)]

105
- Ensure that the drive address select switch on the M7680/M7700 module is set to the first switch position.
- Connect a jumper from A08T1 to A08J2, selecting the drive.
- Connect another jumper from B08H1 (STROBE) to B08N2 (SECTOR PULSE). The positioner should move to the main alignment cylinder of 105. The spare cylinders (85 and 125) should only be used if the main alignment cylinder is not usable.
- Figure E-2 shows how to read the position track scale to verify the movement of the positioner to cylinder 105.

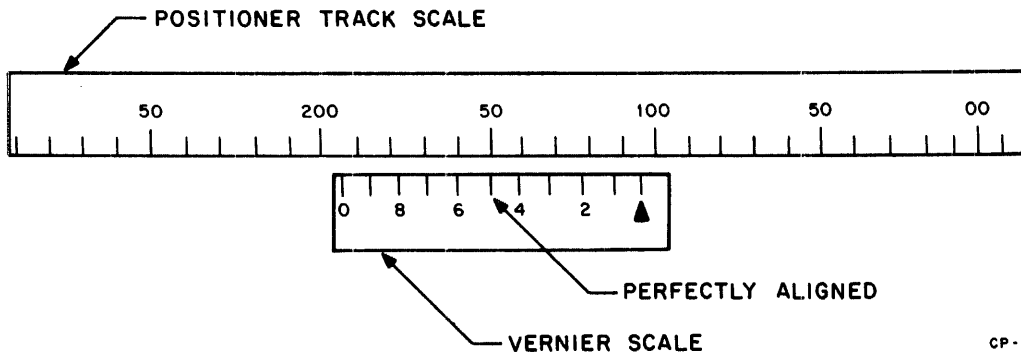

CP-0845

Figure E-2 How to Read a Vernier

- If you are unsure of how to read the scale, read the text given below.
 - Take the whole number value of the nearest positioner track scale marking that is opposite the vernier scale triangle.
 - Take the value of the vernier scale marking that aligns perfectly with any positioner track scale marking.

- Add the two values (see Figure E-2). The nearest positioner track scale marking to the right of the triangle is 100. The number on the vernier scale that aligns perfectly with a positioner track scale marking is 5. Therefore, the scale reads cylinder 105.

SEEK TO THE ALIGNMENT CYLINDER (RK05F)

The RK05-AC alignment cartridge is the same for any RK05 Disk Drive. The primary alignment cylinder for an RK05 or an RK05J is 105. Due to the doubling of the track density for the RK05F, cylinder 105 translates into cylinder 5 of the odd-numbered RK05F drive. Space cylinders 85 and 125 cannot be used by an RK05F.

- Select the odd-numbered drive by connecting a jumper string from A07T1 (or any available ground pin) to the points listed below.
 - A04V1 (SELECT READY)
 - A08K2 (SELECT 1)
 - A08M2 (SELECT 3)
 - A08L1 [CYLINDER ADDRESS 2 (4)]
 - A08K1 [CYLINDER ADDRESS 0 $\frac{(1)}{5}$]

ODD DRIVE SELECTION
- Ensure the drive address select switch on the M7680/M7700 module is set to the first switch position.
- Connect a jumper from A08T1 and A08J2, selecting the drive.
- Connect another jumper from B08HI (STROBE) to B08N2 (SECTOR PULSE). The positioner should move to the main alignment cylinder. The positioner track scale will read cylinder 105 when the drive is positioned properly. The track scale in an RK05F is identical to the track scale in an RK05 or RK05J.

HEAD WAVEFORM CHECK

The drive and cartridge should be thermally stabilized, the track scale aligned, the oscilloscope set up and the drive positioned to the alignment cylinder, with the lower head selected. Observe an oscilloscope display similar to one of those shown in Figure E-3.

NOTE

The bright horizontal line on the left side of the oscilloscope trace indicates proper positioning of the alignment sectors on the screen. All odd-numbered sectors are represented by X1 (at the left side of each display). All even-numbered sectors are represented by X2 (at the right side of each display).

If the line does not appear, adjust the oscilloscope level control until it does.

- a. Extreme misalignment. Head close to CYL 104. (Further misalignment only reduces amplitude of signal on right side of screen until it disappears.)

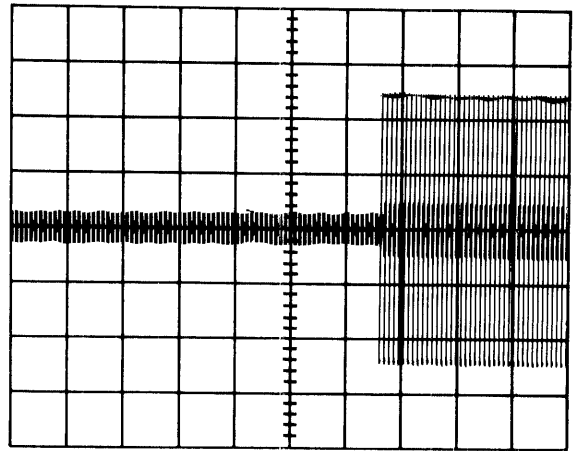

MA-2750

- b. Head slightly misaligned. Smaller left amplitude indicates head position less than CYL 105.

Error = -15%

BRIGHT LINE SHOULD APPEAR HERE

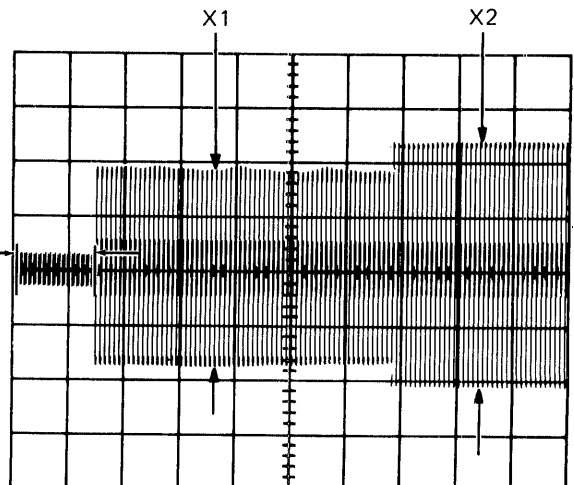

MA-3851

Figure E-3 RK05K-AC Head Alignment Waveform (Sheet 1 of 3)

- c. Head correctly aligned at CYL 105. Amplitudes are equal.

BRIGHT LINE SHOULD APPEAR HERE

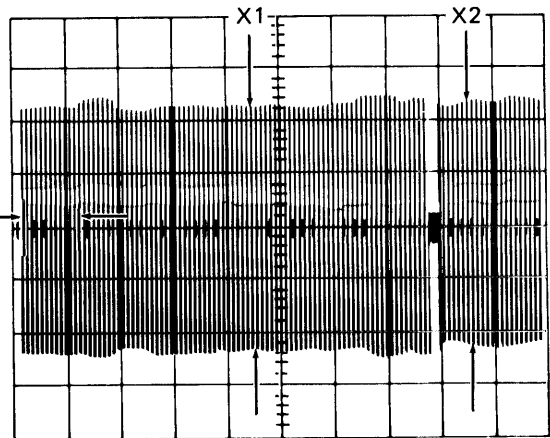

MA-3850

- d. Head slightly misaligned. Larger left amplitude indicates head position more than CYL 105.

Error = +15%

BRIGHT LINE SHOULD APPEAR HERE

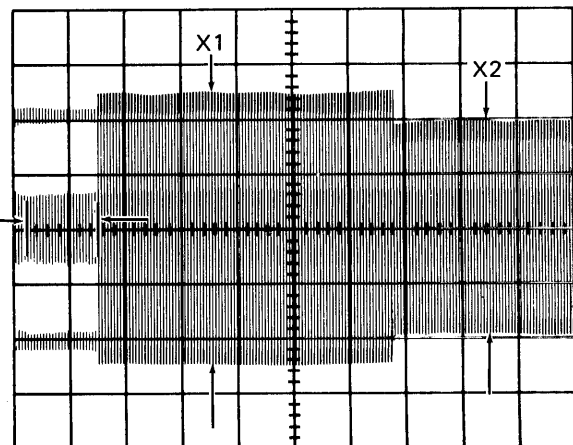

MA-3643

- e. Head considerably misaligned. Larger left amplitude indicates head position more than CYL 105.

Error = +72%

BRIGHT LINE SHOULD APPEAR HERE

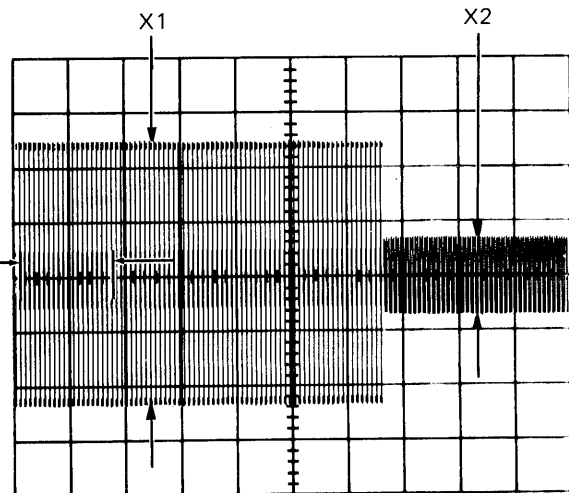

MA-3849

Figure E-3 RK05K-AC Head Alignment Waveform (Sheet 2 of 3)

- f. Extreme misalignment. Head close to CYL 106. (Further misalignment only reduces amplitude of signal on left side of screen until it disappears.)

BRIGHT LINE
SHOULD APPEAR
HERE

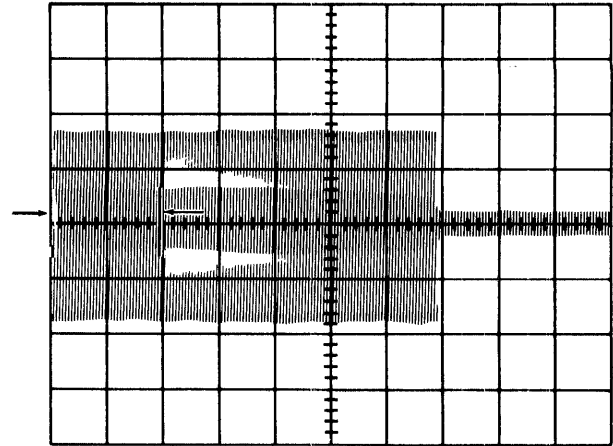

MA3810

Figure E-3 RK05K-AC Head Alignment Waveform (Sheet 3 of 3)

To calculate percent of error, use the formula given below.

$$\% \text{ error} = \frac{X_1 - X_2}{X_1 + X_2} \times 100$$

X_1 and X_2 = amplitudes. The resultant sign denotes the direction of error; a negative (-) sign indicates that the head is back too far.

- If none of the waveforms appear, the head is misaligned so badly that manual movement of the positioner is required to find the alignment cylinder. If this is the case, proceed directly to the head alignment procedures after verifying that the carriage has moved to the alignment cylinder.
- If one of the waveforms is present, note the direction in which the head must be adjusted (see Figure E-3) to obtain correct alignment.

NOTE

Use the formula found with Figure E-3 to determine the amount of misalignment. Views b and d in Figure E-3 illustrate the maximum allowable misalignment. No head alignment should be performed if the amount of misalignment is less than 15%.

HEAD ALIGNMENT PROCEDURE

- Loosen the head clamping and adjustment screws (Figure E-4).

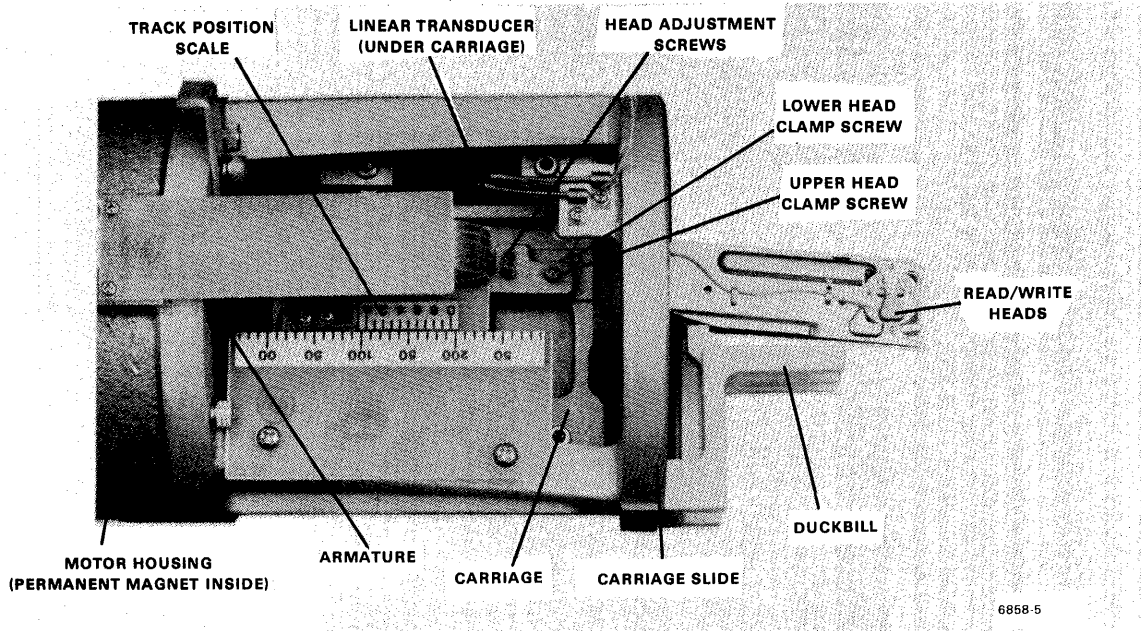

(a) Older Style

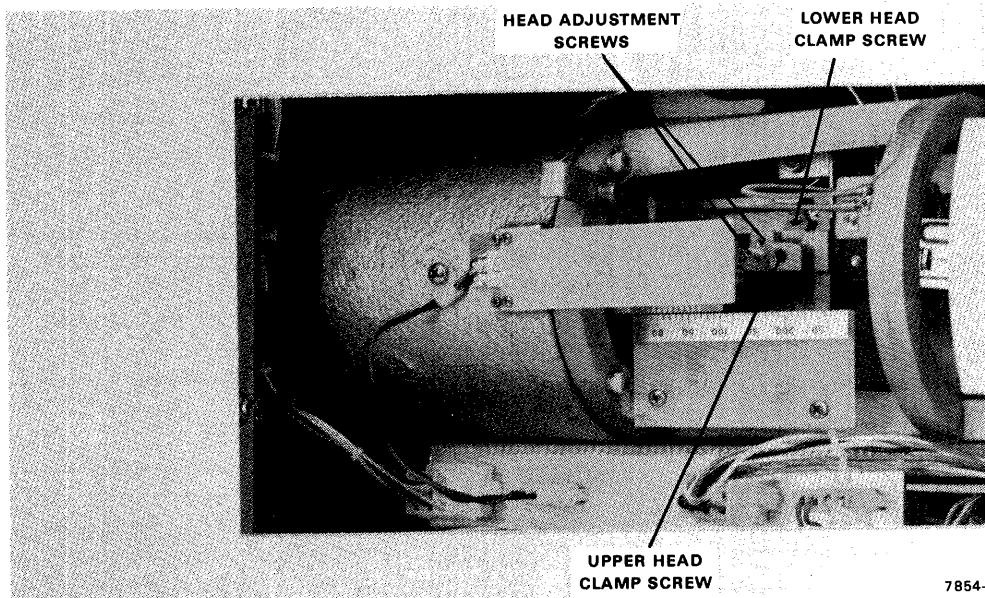

(b) Newer Style

Figure E-4 Read/Write Head Adjustments

NOTE

The jumper method of positioning the heads has selected the lower read/write head for oscilloscope display. Whichever method you have used to seek to the alignment cylinder, ensure that the correct screws are loosened.

- The RK05 heads generally "stick" in place and are not easily moved. To ensure that no damage will be done to the head tailpieces, use the procedure given below to adjust the heads.
 - Push the maintenance switch (S1) on the H604 module down (off).
 - Move the positioner in reverse until the rearmost stop is reached.
 - Free the sticking head by sliding it to the rear of the carriage assembly until the head reaches its stop.
 - Move the positioner forward until the inner limit is reached.
 - Push the maintenance switch up (on). The positioner will automatically perform a restore operation followed by a seek to the alignment cylinder.
 - Head is now out of alignment in the negative (reverse) direction. The adjustment screw can now be used to slide the head forward until the alignment data pattern is correct.

CAUTION

If you have not freed the sticking head before using the adjustment screw, then the screw will gouge the adjustment ramp on the tailpiece of the head, making alignment almost impossible.

- Snug the head clamp screw with the appropriate hex-wrench.
- Loosen the adjustment screw slightly to relieve pressure on the adjustment ramp of the head.
- Observe the oscilloscope waveform while tightening the head clamping screw with the appropriate torque wrench.

CAUTION

Ensure the proper torque wrench is being used to tighten the head clamping screw. Older carriages use conical-tipped screws that apply pressure to the sides of the head support arms holding them in place. These screws are to be torqued down at 55 ounce-inches.

Newer carriages use brass-tipped screws that apply pressure directly on the head support arms. These screws are to be torqued down at 128 ounce-inches.

- The alignment waveform may move while you are tightening the screws. Observe the amount of movement during the tightening process, then loosen the head screws and readjust. You may find that in order to obtain perfect alignment after tightening, the adjustment should be made such that the tightening process completes the alignment. This procedure will take some amount of practice before you feel comfortable with it.
- Connect a jumper from A07C2 (or any available ground pin) to B08M2 selecting the upper head.
- Repeat the entire alignment procedure (from head waveform check) to adjust the upper head.
- Upon completion, go to Appendix F and perform the index/sector timing adjustment.

APPENDIX F INDEX/SECTOR TIMING ADJUSTMENT

This adjustment normally follows the head alignment to check and compensate for slight amounts of head skew. If this adjustment is following a head alignment, start these procedures from Step 2. If not, proceed with the steps listed below.

1. Preliminary Drive Set-Up

- Unplug the ac line cord.
- Disconnect the drive interface cable from the drive logic.
- Install an M930 terminator in its place.
- Reconnect the ac line cord.
- Load an RK05-AC alignment cartridge.
- Press the RUN switch to load the heads.
- Allow the cartridge to thermally stabilize for at least 30 minutes before attempting alignment.

NOTE

Thermal stabilization is extremely important to the accuracy of the alignment. Do not bypass or shortcut this step.

- Press the WRITE PROTECT switch, ensuring that the alignment cartridge cannot be accidentally written on.

2. Oscilloscope Set-Up Procedures

- Vertical mode = channel A
- Vertical sensitivity = 20 millivolts/division
- Vertical coupling = dc
- Sweep time = 10 microseconds/division
- Trigger mode = normal
- Trigger source = external
- Trigger coupling = ac
- Connect a X1 probe from the external trigger to A02R2 (INDEX)

- Connect a X10 probe from channel A to TP3 of the G180 module
3. Read the track scale. With the heads loaded, the scale should be at 00.
- 4a. Seek to the Alignment Cylinder (RK05/05J)
- Using the backplane jumper method, connect a jumper string from A07T1 (or any available ground) to the points listed below.
 - A08E1 [Cylinder address 6 (64)]
 - A08J1 [Cylinder address 5 (32)]
 - A08C1 [Cylinder address 3 (8)]
 - A08K1 [Cylinder address 0 (1)]

$$\frac{\quad}{105}$$
 - Ensure that the drive address select switch is set to the first switch position.
 - Connect a jumper from A08T1 to A08J2, selecting the drive.
 - Connect another jumper from B08H1 (STROBE) to B08N2 (SECTOR PULSE). The positioner should move to the main alignment cylinder of 105. The spare cylinders (85 and 125) should only be used if the main alignment cylinder is not usable.
 - Figure F-1 shows how to read the position track scale to verify the movement of the positioner to cylinder 105.

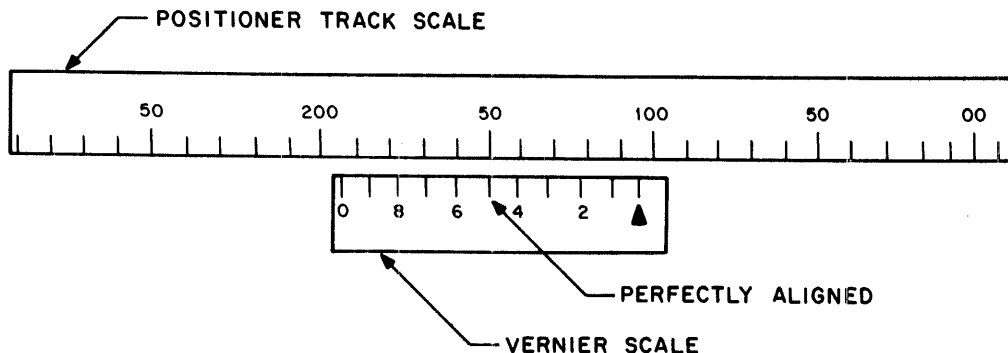

CP-0845

Figure F-1 How to Read a Vernier

- If you are unsure of how to read the scale, read the steps given below.
- Take the whole number value of the nearest positioner track scale marking that is opposite the vernier scale triangle.

- Take the value of the vernier scale marking that aligns perfectly with any positioner track scale marking.
 - Add the two values (see Figure F-1). The nearest positioner track scale marking to the right of the triangle is 100. The number on the vernier scale that aligns perfectly with a positioner track scale marking is 5. Therefore, the scale reads cylinder 105.
- 4b. Seek to the Alignment Cylinder (RK05F)
 The RK05-AC alignment cartridge is the same for any RK05 Disk Drive. The primary alignment cylinder for an RK05/05J is cylinder 105. Due to the doubling of the track density for the RK05F, cylinder 105 translates into cylinder 5 of the odd-numbered RK05F. Spare cylinders 85 and 125 cannot be used by an RK05F.
- Select the odd-numbered drive by connecting a jumper string from A07T1 (or any available ground pin) to the points listed below.
 - A04V1 (SELECT READY)
 - A08K2 (SELECT 1)
 - A08M2 (SELECT 3)
 - A08L1 [Cylinder address 2 (4)]
 - A08K1 [Cylinder address 0 $\frac{(1)}{5}$]
- ODD DRIVE SELECTION
- Ensure that the drive address select switch on the M7680/M7700 module is in the first switch position.
 - Connect a jumper from A08T1 to A08J2, selecting the drive.
 - Connect another jumper from B08H1 (STROBE) to B08N2 (SECTOR PULSE). The positioner should move to the main alignment cylinder. The positioner track scale will read cylinder 105 when the drive is positioned properly. The track scale in an RK05F is identical to the track scale in an RK05 or an RK05J.
5. The oscilloscope should display a waveform of the lower head similar to that shown in Figure F-2.

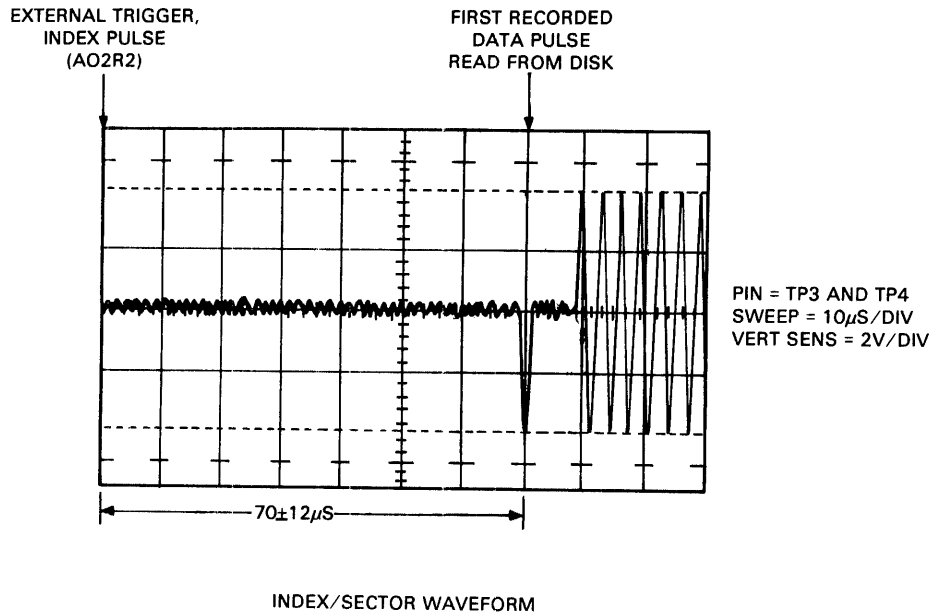

CZ-0293

Figure F-2 Index/Sector Waveform

The oscilloscope is triggered on the index pulse of the alignment cartridge. The alignment cartridge is designed such that, 70 microseconds after the index marker, a single data pulse is recorded followed by a stream of data. This single pulse may be positive- or negative-going.

6. Measure the time difference between the start of the sweep (triggered on the index pulse) and the first recorded data pulse on the oscilloscope trace.
 - The tolerance of the time difference is $70 + 12$ microseconds. If the time difference is not within this tolerance, the upper head must next be checked to determine the exact amount of misalignment.
7. To check the upper head, ground B08M2.
8. Measure the time difference between the start of the sweep and the first recorded pulse.
 - The tolerance of the time difference is 70 ± 12 microseconds.
9. Compute the average of the two measurements. The upper head time difference plus the lower head time difference, divided by two, equals the average.
 - The average of the two measurements must be 70 microseconds.

10. If the lower head, upper head or average measurements are out of specification, adjust R6 on the M7680/M7700 module (slot 2) until the average time for the two pulses is 70 microseconds. The individual pulse requirement of 70 ± 12 microseconds must also be maintained. If these requirements cannot be achieved, perform one of the two corrective measures listed below.

- If the time difference of the two timing pulses exceeds 24 microseconds, replace the upper head and recheck the adjustment. If the difference is now within specifications, readjust R6 to achieve the average of 70 microseconds between the pulse peaks. If, after replacing the upper head, the difference between the two pulse peaks is still out of tolerance, then the lower head must be replaced, and the adjustment rechecked with two new heads. Once the difference is within tolerable limits, readjust R6 to meet the specification.
- If the average of the pulse peaks cannot be adjusted to 70 microseconds, the sector transducer block must be adjusted.
 - If the average is too high, loosen the screws on the sector transducer and move the transducer to the right.
 - If the average is too low, loosen the screws on the transducer and move the transducer to the left.
- In either case, R6 must be readjusted to achieve an average of 70 microseconds between the peaks.
- If one or both of the read/write heads were replaced, then the head alignment must be performed (see Appendix E).
- Upon completion of a head alignment and an index/sector timing adjustment, the read data separator should be checked and adjusted if necessary. Appendix G contains the directions to perform this adjustment/check.

APPENDIX G
READ DATA SEPARATOR ADJUSTMENT

1. Place a scratch cartridge into the drive.
2. Using the maintenance switch (S1 on the H604 module), manually position the heads at any recorded cylinder past zero.

NOTE

Allow the heads to load under logic control, then place a finger on the carriage while opening switch S1. This will preclude the possibility of carriage motion caused by transient switch noise.

3. Set-Up Oscilloscope
 - Vertical mode = channel A
 - Vertical sensitivity = 1 volt/division
 - Trigger source = channel A
 - Vertical coupling = dc
 - Sweep time = 0.1 microseconds/division
 - Trigger mode = normal
 - Trigger coupling = ac
 - Slope = positive
 - Connect channel A probe to TP1 of the G180 module (slot 1)
4. Adjust CL (R55; lower pot) on the G180 module fully counterclockwise.
5. Adjust OL (R54; upper pot) on the G180 module fully clockwise.
6. Adjust R54 upper pot counterclockwise to obtain a 500 +40 nanosecond pulse. This is measured from the start of the rise to the start of the fall.

NOTE

Oscilloscope sweep synchronization is possible at the sweep start only. Disregard the unsynchronized pulses that follow.

7. Adjust CL (R55; lower pot) clockwise until the 500 nanosecond pulse decreases in width to 440 ± 10 nanoseconds. This is also measured from the start of the rise to the start of the fall.

NOTE

A pack with an all-zero data pattern will be easier to adjust, although any data pattern will suffice.

NOTE

Moving the positioner to another data cylinder may also aid the adjustment by yielding a clearer oscilloscope presentation.

Digital Equipment Corporation • Bedford, MA 01730